



HYDRATION STATION

Technical Manual



Part Number: 350092

westomatic
make it happen

1. Receiving your Machine

- Westomatic will deliver your machine and assist with the initial installation and training.
- Your machine will already be set up to your specifications - taken from your order.
- When you receive your machine it's important that you check for any damage in transit - please report these directly to Westomatic HQ as soon as possible.
- The H2O Hydration Station is intended to deliver drinks at $<5^{\circ}\text{C}$ into the customers own reusable bottle.
- The water is triple filtered using sediment, UV and 0.1 micron filters.
- The dispenser can be set up for water only or water and juice/cordial options.
- This Technical manual provides guidance to install, operate and clean your H2O Hydration Station.



2. External Features



DIGITAL MEDIA SCREEN

LCD DISPLAY

ILLUMINATED DRINKS MENU

IR REMOTE CONTROL FOR MEDIA SCREEN

HOVER SELECT BUTTONS 1, 2, 3, 4

CASHLESS BLANKING PLATE

MORE THAN JUST WATER

LED LIT BOTTLE STATION

BOTTLE SENSOR

SECURITY T LOCK

CHILLED - MICRO FILTERED - PURE

REMOVABLE SIDE/FRONT KICK PLATES

3. Internal Features

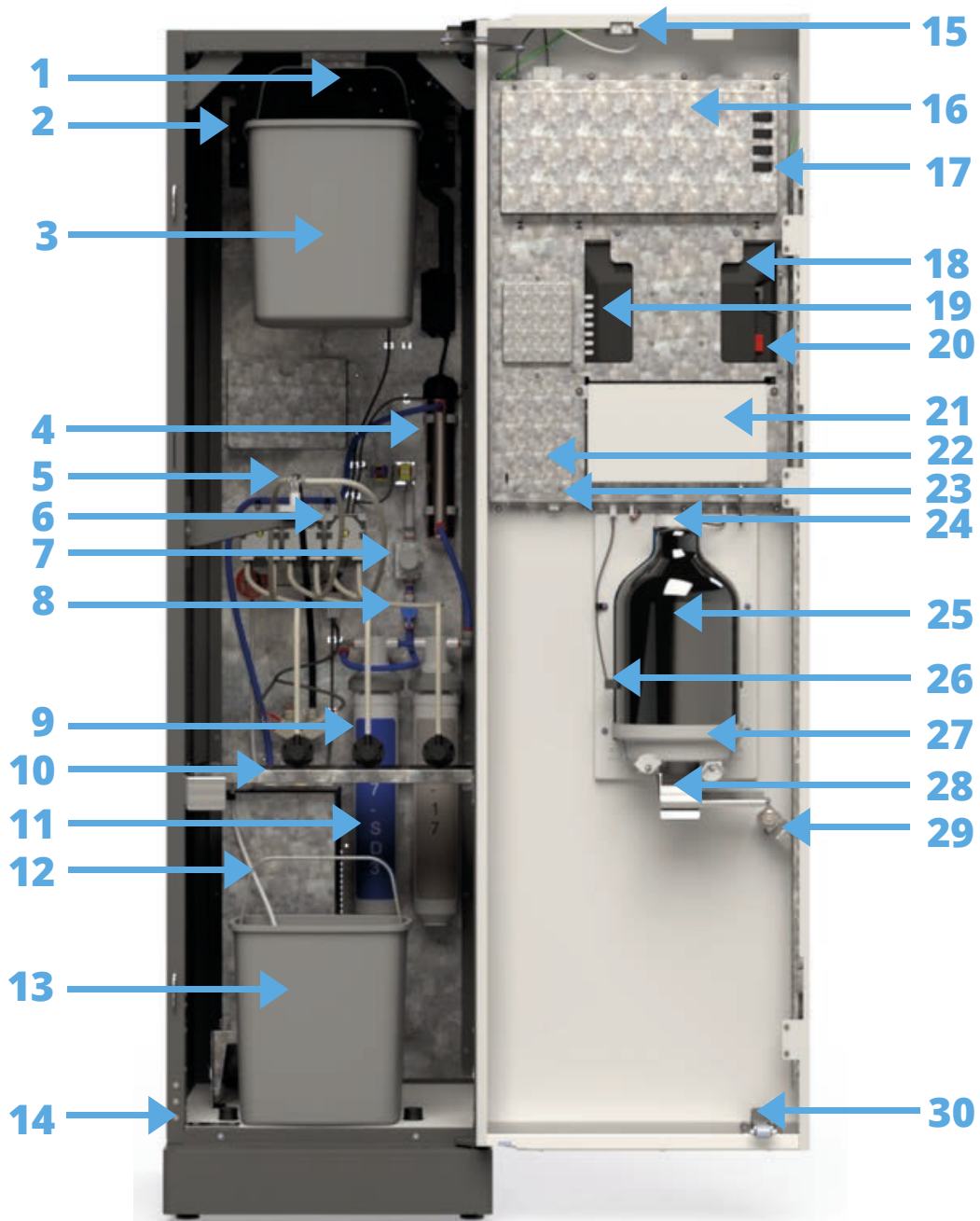

1	F & D Fuse Box	15	Service Switch
2	Power Button	16	VMC Cover Plate
3	Sanitising & Cleaning Bucket	17	Flush / Prime Buttons
4	UV Filter	18	Digital Media Display
5	Dispense Head	19	Digital Control Buttons
6	Juice Pumps	20	Digital Media SD / USB Ports
7	Pressure Regulator	21	Illuminated Drinks Menu
8	Water Stop Valve	22	Cashless Cover Plate
9	Bag in Box Connector	23	Audit USB / Config Port
10	Storage Shelf	24	White Bottle Station Light
11	Water Filters	25	Bottle Station
12	Bucket Full Sensor	26	Bottle Sensor
13	Waste Bucket	27	Drip Tray
14	Door Support	28	Wastewater Guide
		29	Security T Lock
		30	Door Level Guide

4. Water Flow Diagram

WATER INLET:

- 24VDC - Controls when water can enter machine.
- Prevents continual mains water pressure within the machine

DISPENSE HEAD:

- Water/Juice flow to bottle.

STOP VALVE:

- Allows you to manually turn off and isolate water supply.
- Helps remove water and pressure from the system before changing the filters
- Ensure water flush button is pressed to run water out of system

DISPENSE VALVE:

- Main filtered water dispenses to dispense head.

WATER CHILLER:

- Water chiller chills filtered mains water to deliver cold drinks between 3°C & 5°C.

UV WATER FILTER:

- Sterilises the water supply to remove any bacteria not removed by the water filters.
- Purifies at rate of 1 gallon per minute

⑤

②

PRESSURE REGULATOR:

- Controls incoming water pressure to the required flow rate.
- Clockwise to increase
- Counter-clockwise to decrease

④

WATER FILTER:

- Dual water filter removes sediment / contaminants down to 5 microns.
- Water filter (blue) must be fitted on the left

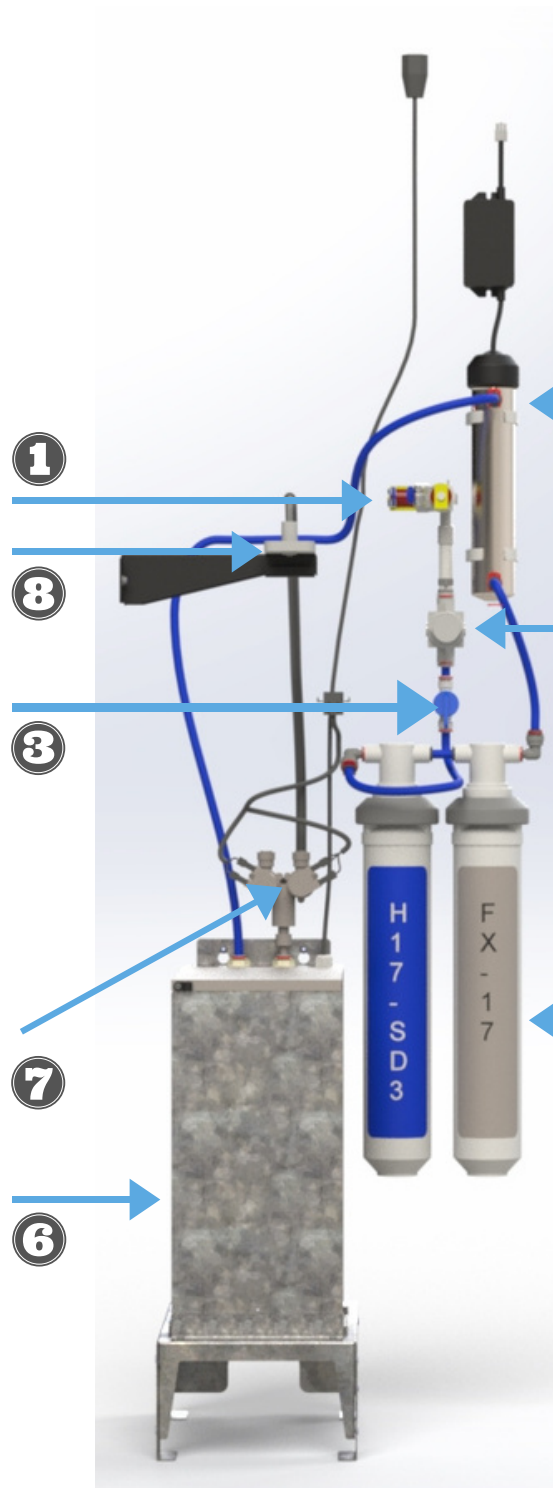

4. Water + Juice Flow Diagram

WVS STANDARD - DIP TUBES

WATER INLET:

- 24VDC - Controls when water can enter machine.
- Prevents continual mains water pressure within the machine

DISPENSE VALVE & HEAD:

- Main filtered water dispenses from valve to dispense head.
- Water/Juice flow to bottle.

SYRUP PUMPS:

- Drive juice from box / container into dispense line.

STOP VALVE:

- Allows you to manually turn off and isolate water supply.
- Helps remove water and pressure from the system before changing the filters
- Ensure water flush button is pressed to run water out of system.
- (Behind the bottles)

WATER CHILLER:

- Water chiller chills filtered mains water to deliver cold drinks between 3°C & 5°C.

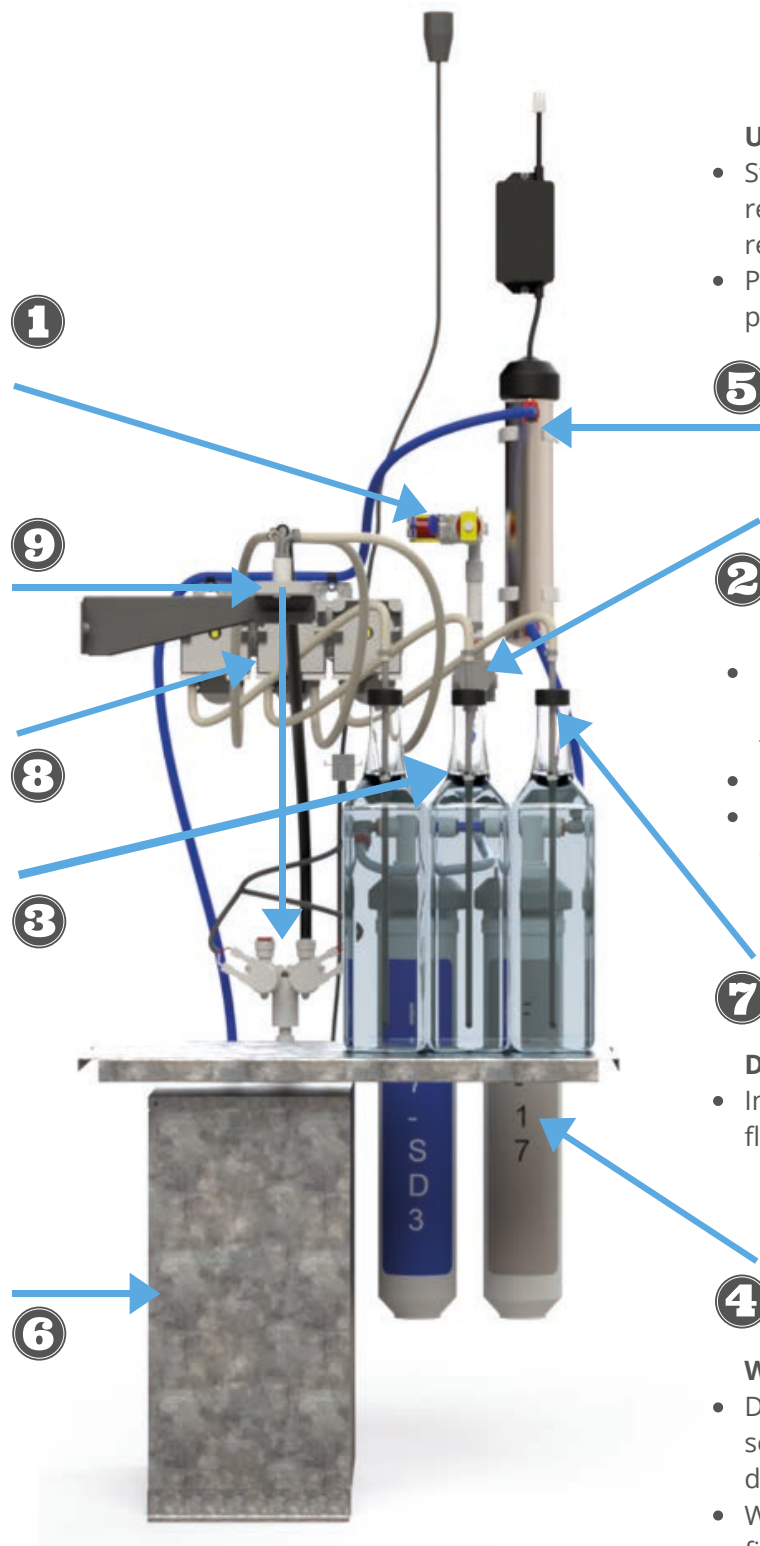

UV WATER FILTER:

- Sterilises the water supply to remove any bacteria not removed by the water filters.
- Purifies at rate of 1 gallon per minute

PRESSURE REGULATOR:

- Controls incoming water pressure to the required flow rate.
- Clockwise to increase
- Counter-clockwise to decrease

DIP TUBES:

- Individual tubes for each flavour.

WATER FILTER:

- Dual water filter removes sediment / contaminants down to 5 microns.
- Water filter (blue) must be fitted on the left

4. Water + Juice Flow Diagram

BAG IN BOX OPTION

- WATER INLET:**
- 24VDC - Controls when water can enter machine.
 - Prevents continual mains water pressure within the machine
- DISPENSE HEAD:**
- Water/Juice flow to bottle.
- SYRUP PUMPS:**
- Drive juice from box / container into dispense line.
- STOP VALVE:**
- Allows you to manually turn off and isolate water supply.
 - Helps remove water and pressure from the system before changing the filters
 - Ensure water flush button is pressed to run water out of system
- WATER CHILLER:**
- Water chiller chills filtered mains water to deliver cold drinks between 3°C & 5°C.

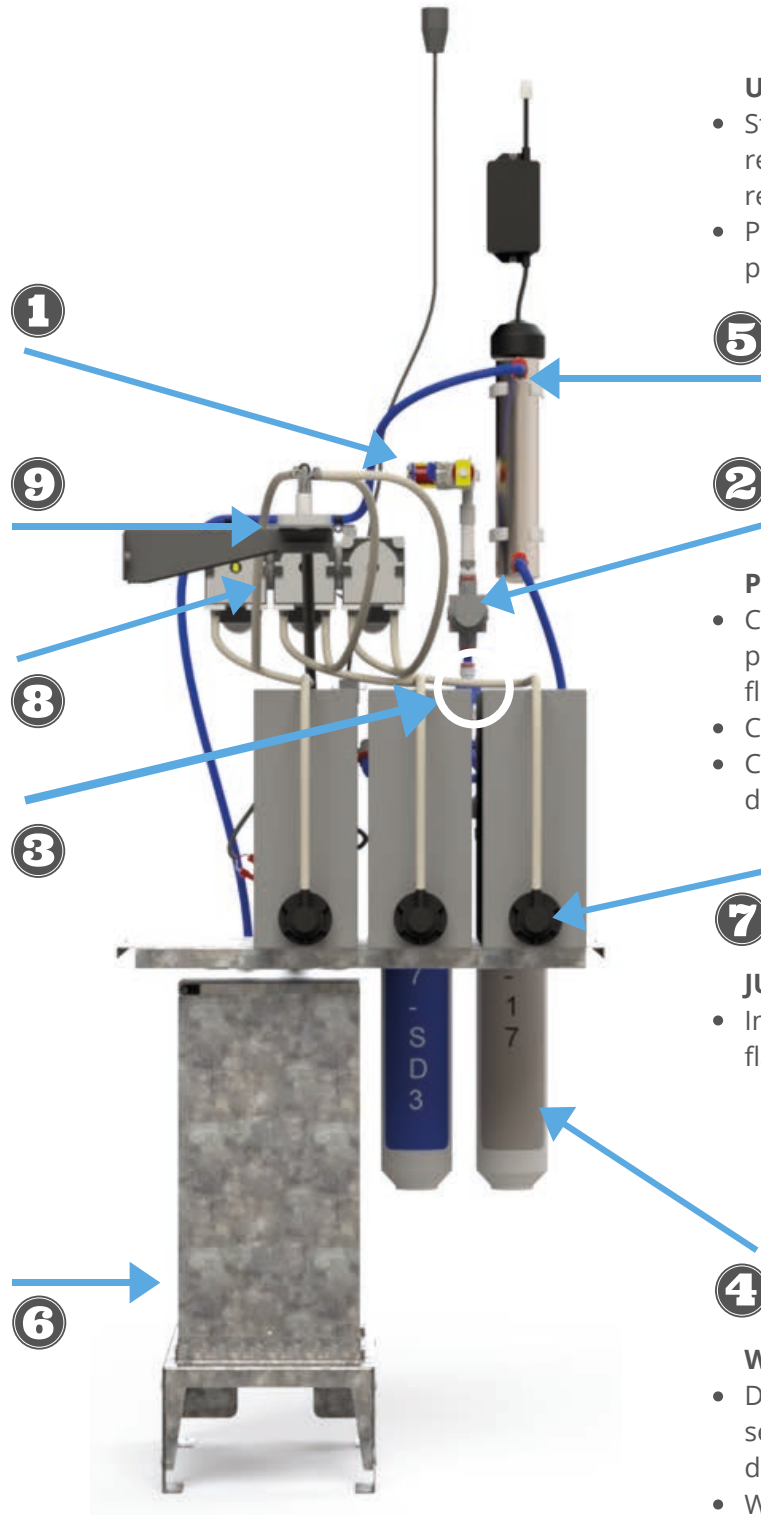

- UV WATER FILTER:**
- Sterilises the water supply to remove any bacteria not removed by the water filters.
 - Purifies at rate of 1 gallon per minute

- PRESSURE REGULATOR:**
- Controls incoming water pressure to the required flow rate.
 - Clockwise to increase
 - Counter-clockwise to decrease

- JUICE CONNECTOR + BOXES:**
- Individual valves for each flavour.

- WATER FILTER:**
- Dual water filter removes sediment / contaminants down to 5 microns.
 - Water filter (blue) must be fitted on the left

5. Juice Flow Diagram

WVS STANDARD - DIP TUBES

DISPENSE HEAD:

- Where the water and the juices combine to deliver a mixed drink into the bottle.
- The dispense head is removable for cleaning.

JUICE PUMPS:

- Control the amount of juice dispensed into the bottle.
- Run for a time set in the drink recipe in seconds.
- An optional 3rd juice kit can be added to the machine.

DIP TUBES:

- Fits onto a wide range of containers or bottles.
- Juice is pumped out of bottles, through the pump and into the dispense pipe.

2

3

1

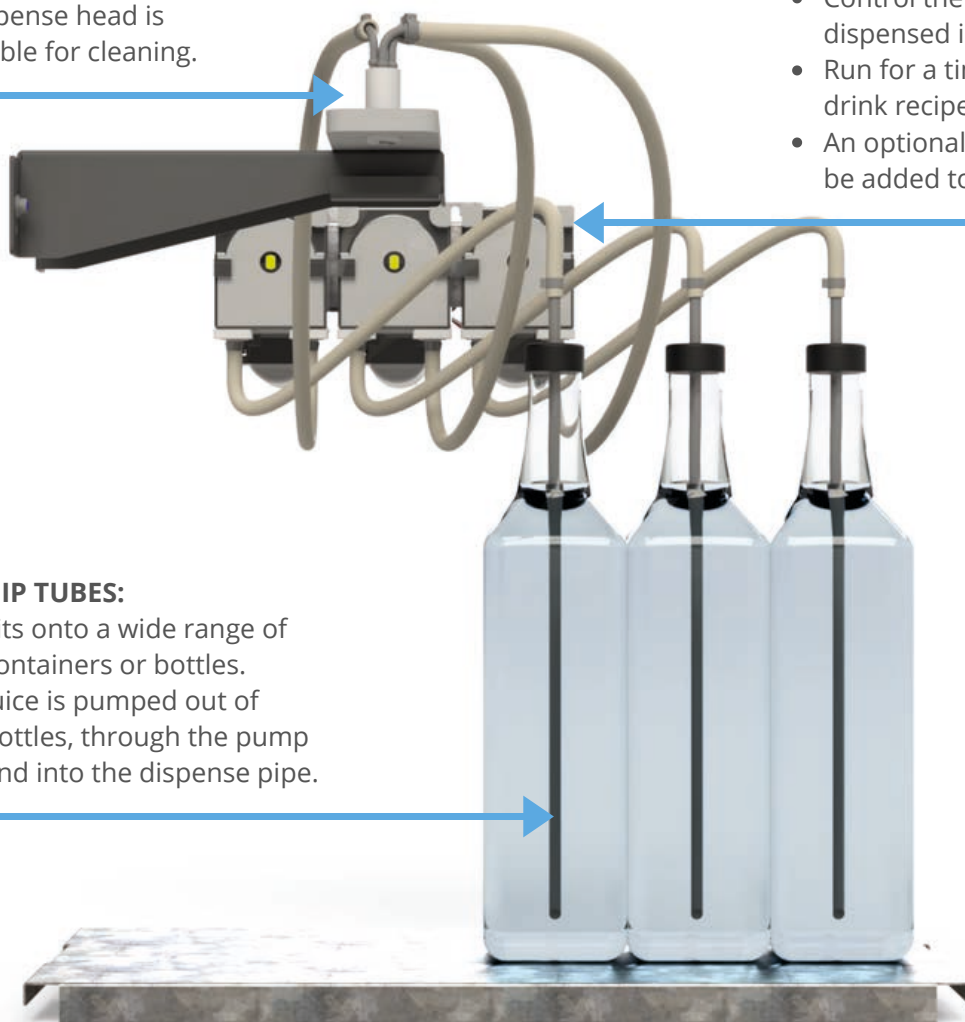

5. Juice Flow Diagram

BAG IN BOX OPTION

DISPENSE HEAD:

- Where the water and the juices combine to deliver a mixed drink into the bottle.
- The dispense head is removable for cleaning.

2

JUICE PUMPS:

- Control the amount of juice dispensed into the bottle.
- Run for a time set in the drink recipe in seconds.
- An optional 3rd juice kit can be added to the machine.

3

BAG IN BOX CONNECTOR:

- Connects to juice pouch.
- Forms an airtight seal for health and safety.
- Juice is pumped out of bags, through the pump and into the dispense pipe.

1

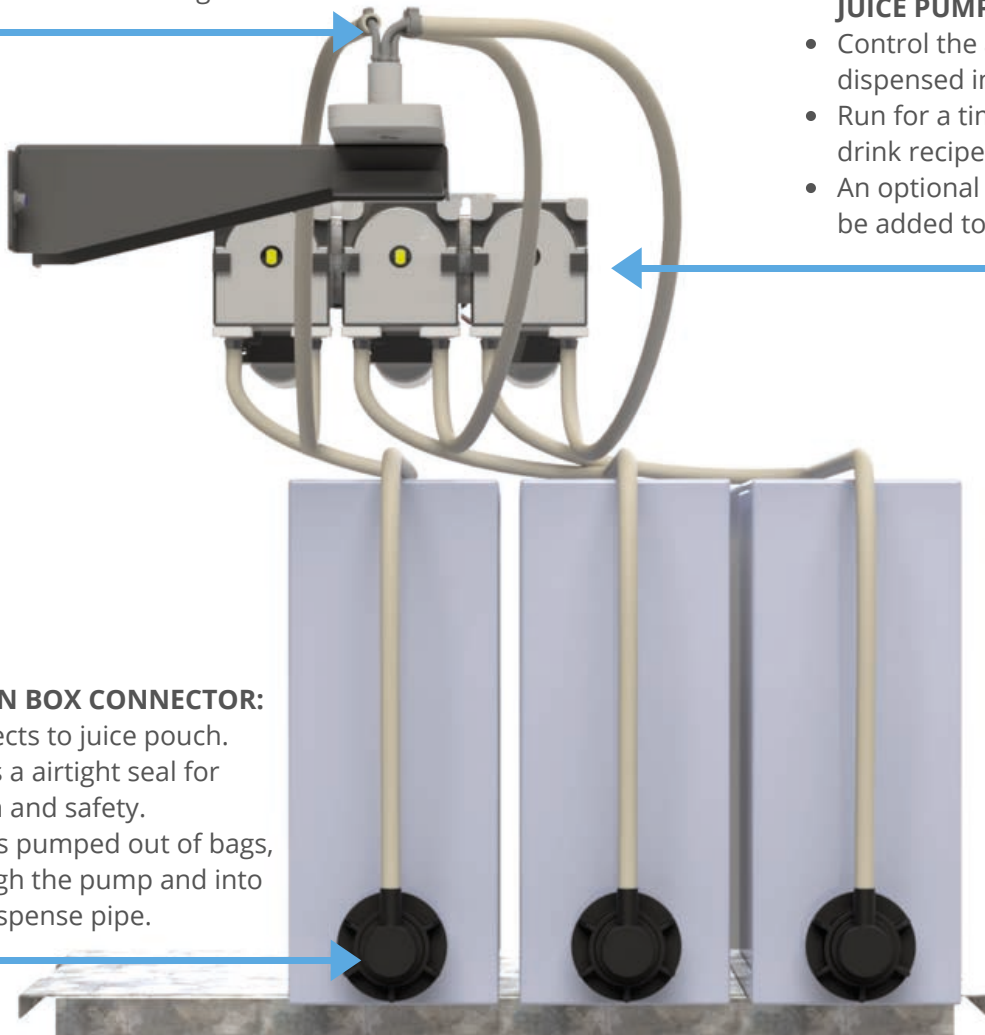

6. Installation

1. COMMISSIONING WATER

- The H2O Hydration Station is not suitable for outdoor use or for being jet washed in any way.
- Ensure there is a minimum of 100mm of free space behind the machine to allow for ventilation of chiller.
- The machine must be **switched off** before you begin.

①



②



- Connect hose to mains water supply / potable water.
- Min water pressure = 0.13-0.84 MPa / 1.4 - 8.4 Bar.
- Check filters and fit them to the machine
- NB. Sediment filter (blue) must be fitted on the left.

③



④



- Turn water on & **CHECK FOR INTERNAL / EXTERNAL LEAKS**
- Plug machine in and power on machine.
- Prime filters by flushing water through. Repeat until the water runs clear and all air is eliminated.

6. Installation

2. LEVELLING

- Locate the machine on a stable, level surface.
- You will need a spanner and a spirit level.
- Incorrect levelling can lead to misalignment and inconsistent bottle fill issues.

1



2

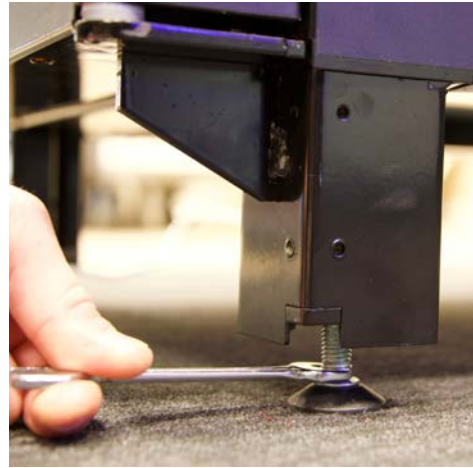

- Using the spanner adjust the foot bolts to raise or lower the machine.
- Ensure you check side to side and front to back to ensure machine is level in both planes.

3



4



6. Installation

3. FITTING THE PLINTHS

- The H20 Hydration Station comes with 2x side plinths, and 1x front - these are packed up securely inside the machine for delivery.
- Locate the machine into place before fitting the plinths.
- The nuts will be pre-fitted - and must be facing the front (ensuring the nuts are closer to the bottom of each plinth).

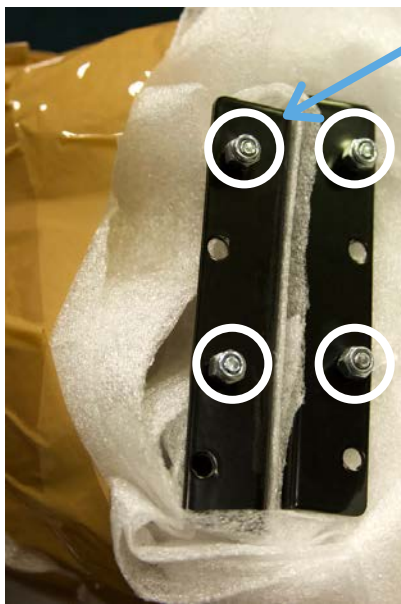

Plinths will have nuts fitted

The nuts must be located closer to the bottom when fitting

The nuts fit into a keyhole connection with the front plinth

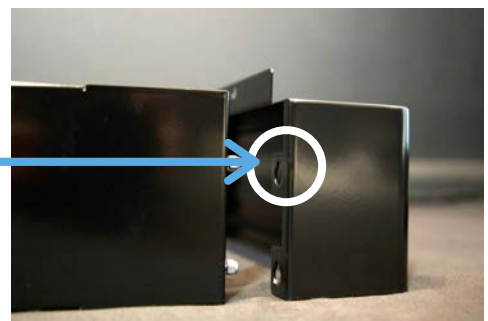
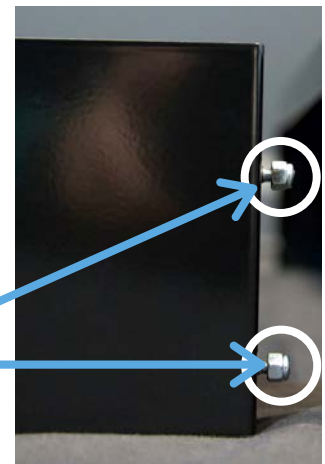

6. Installation

FIT SIDE PLINTHS

1. Remove the screws from the front legs of the machine.
2. Slide plinth into back first.
3. Fit the plinth to the front ensuring it lines up with holes
4. Replace screws & repeat on the other side.

1

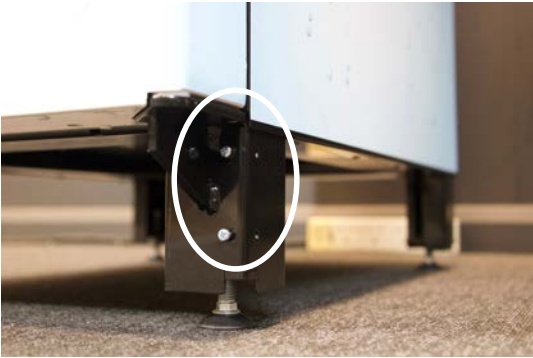

Remove screws

2

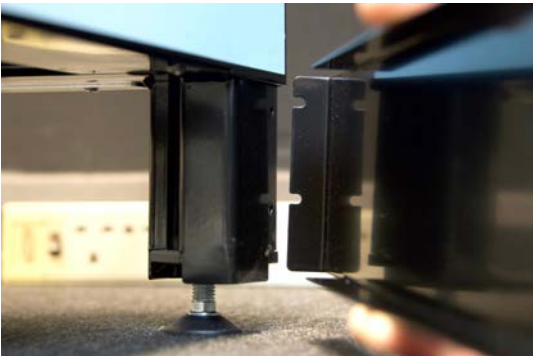

Slide plinth into back of machine first

3



Fit plinth to front

4

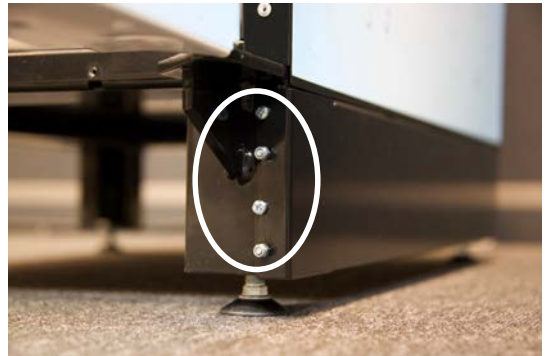

Replace screws

5

Repeat steps on other side

6. Installation

FIT FRONT PLINTHS

1. Remove the countersunk screws.
2. Fit front plinth on to the nuts on the side plinths.
3. Slide the front plinth up so it aligns with countersunk screws.
4. Replace screws on both sides.

1



Remove countersink screws x2

3



Replace screws x2

2

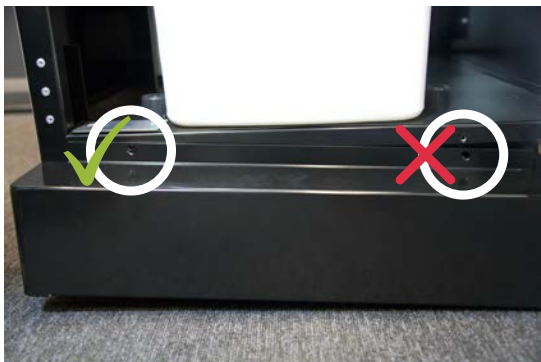

Ensure plinth and countersink align

4



Plinths fitted on both sides and front

7. Commissioning

1. INSERTING FLAVOUR DECALS

- Westomatic will fit the flavour decals that were specified during the order process.
- Each machine comes with a set of 12 different flavours.
- These are located in the welcome pack at the back of the machine.



LIGHTBOX / DECALS

Unscrew plastic nuts by hand



Lightbox is designed to tilt out - easy for fitting decals

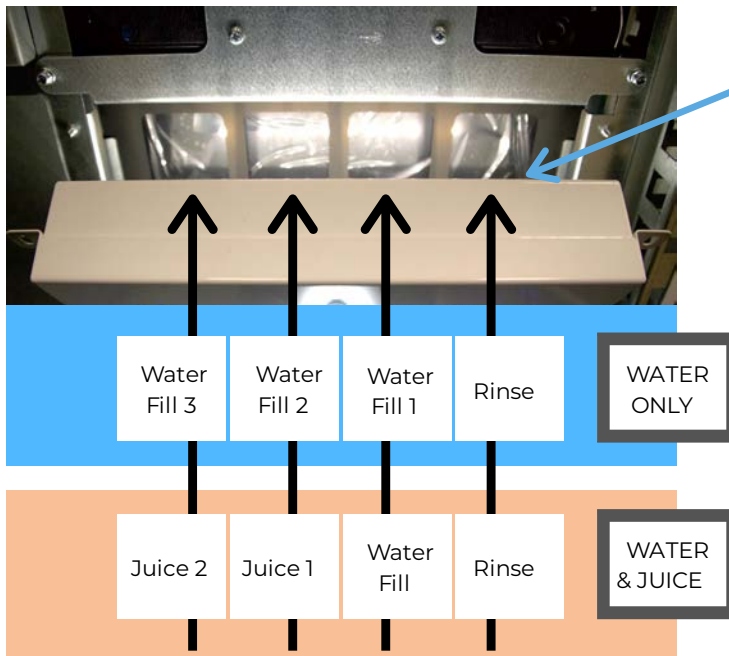

Decals slide easily into Lightbox. Making sure front faces out.

Refit the lightbox and replace the plastic nuts.

7. Commissioning

2. SETTING UP DRINKS

- Westomatic will pre-set the drink settings as per the order specification. If not the default settings are below.
- Each H2O Hydration Station comes set up with a Bottle rinse and 3 water volume options.
- Each H2O Hydration + Juice Station comes set up as standard with a Bottle rinse, a water fill and 2 juice options.

DEFAULT MACHINE TYPES	BUTTON ALLOCATIONS			
	BUTTON 1	BUTTON 2	BUTTON 3	BUTTON 4
SMALL WATER ONLY	Bottle Rinse	200ml Bottle	300ml Bottle	500ml Bottle
LARGE WATER ONLY	Bottle Rinse	300ml Bottle	500ml Bottle	750ml Bottle
SMALL JUICE x2	Bottle Rinse	300ml Bottle	300ml Juice 1	300ml Juice 2
LARGE JUICE x2	Bottle Rinse	500ml Bottle	500ml Juice 1	500ml Juice 2
SMALL JUICE x3	Bottle Rinse	300ml Juice 1	300ml Juice 2	300ml Juice 3
LARGE JUICE x3	Bottle Rinse	500ml Juice 1	500ml Juice 2	500ml Juice 3

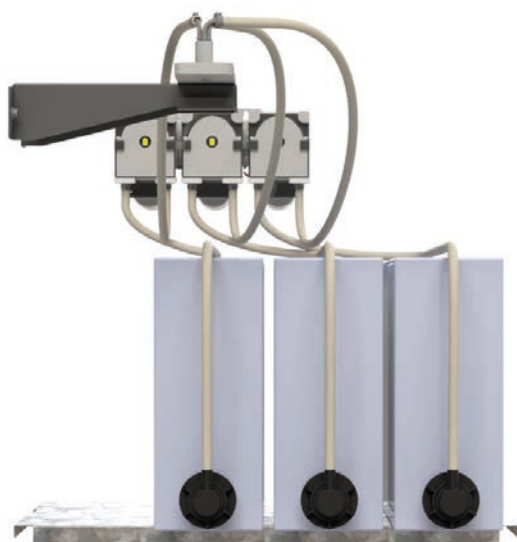

To fit Juice Boxes:

1. Place box on shelf and open to locate box fill valve.
2. Connect juice box to juice line connector.
3. Clockwise to connect / Anti-clockwise to disconnect.
4. Once the fit is secure, flush to prime the juice into the lines.
5. Test drink.

8. How to make a Drink

SETTING FLOW RATE

FACTORY DEFAULT SETTING = 500ML IN 15S
FLOW RATE = 33.3ML/S

BOTTLE FILL CALCULATION:

$$\frac{\text{BOTTLE SIZE}}{\text{FLOW RATE}} = \text{TIME IN SECONDS}$$

EG:
$$\frac{330\text{ML}}{33.3\text{ML/S}} = 9.9\text{S}$$

- For example for a 330ml drink - 9.9 seconds is entered into the water throw time.
- For a 500ml drink - 15seconds
- For a 750ml drink - 22.7seconds

8. How to make a Drink

ADJUST FLOW RATE

- Using a measuring jug or measured bottle fill dispense a bottle fill of a set amount, for example 500ml.
- Adjust the water pressure regulator to achieve correct volume.



- If the water pressure needs adjusting
- The Pressure Regulator is located at the back pf the machine
- Pull cap on regulator out then turn



Clockwise = INCREASES Volume



Anti - Clockwise = DECREASES Volume

8. How to make a Drink

JUICE SET UP

JUICE SET UP:

- A Juice recipe is water throw and a juice throw.
- Water throw is calculated using the equation previous.
- Juice is normally labeled on the bag in box as a ratio of water to juice at 1:9 - this is for a 330ml bottle fill.

FOR EXAMPLE:

- If Product recommendations suggest a 1:9 ratio for a 330ml bottle fill.
- Ratio 1 + Ratio 2 = Total number of parts i.e. 1 + 9 = 10
- So 10 = total number of parts to make a 330ml drink
- 330ml drink ÷ 10 parts = 33ml per part
- 1 part = 33ml and 9 parts = 297ml
- Using the Water equation:

$$\frac{\text{BOTTLE SIZE}}{\text{FLOW RATE}} = \text{TIME IN SECONDS} \quad \frac{297\text{ML}}{33.3\text{ML/S}} = 8.9\text{S}$$

- Water Throw time for Still+Juice 1 = 8.9seconds.
- For the juice throw it cannot be predetermined as each product is different.
- To calculate the juice throw set the throw time for juice to 5.0 seconds and perform a test vend and capture the juice throw only into a measuring cup - allowing the water to discard into the waste bucket.

8. How to make a Drink

JUICE SET UP

- Measure the volume of juice dispensed.
- eg. For a 5s test vend = 20ml juice as measured
- Therefore 1ml of juice = $5\text{seconds} \div 20\text{ml} = 0.25\text{seconds}$
- Using the 1:9 ratio to make 330ml bottle fill - meaning 1 part juice = 33ml (and 9 parts water = 297ml)
- So Throw time for Juice = $33\text{ml} \times 0.25\text{s} = 8.25\text{seconds}$

Using the example here:

- The water dispense time should be entered as 8.9seconds
- The juice dispense time should be entered as 8.25seconds

IMPORTANT:

*Water throw time should always be **greater** than juice throw time to ensure a well blended drink.*

9. Ready?



CHECK LIST:

IMPORTANT TO ENSURE MACHINE IS READY TO DISPENSE:

MACHINE IN LOCATION & LEVELLED

PLINTHS FITTED

POWER ON

WATER ON

WATER FILTERS FITTED & PRIMED

UV FILTER FITTED

*JUICE BAG IN BOX CONNECTED

*JUICE PRIMED

DRINK DECALS IN PLACE

DRINK DISPENSE SET UP

PIPES & NOZZLES FITTED

WASTE BUCKET IN PLACE

WASTE WEIGHT/TUBE IN BUCKET

CLOSE DOOR/BOTTLE IN & DETECTED

TEST ALL DRINKS



*IF FITTED

10. Cleaning and Hygiene

CONTACT PARTS

- The H20 Hydration Station has several contact parts that need to be maintained and replaced as the machine ages.
- We have supplied you with a Hygiene Kit that allows parts to be swapped out when cleaning - ensuring the machine has no 'downtime'.
- There is a sanitation hook fitted to allow the sanitation bucket to be attached when flushing the lines.

HYGIENE KIT



BOTTLE STATION

MORE THAN JUST WATER



FLUSH WATER / JUICE



DRIP TRAY & CHUTE



WASTE BUCKET AND FULL WEIGHT

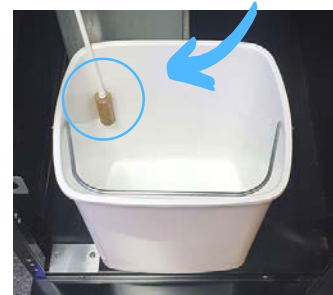

10. Cleaning and Hygiene

1. DAILY CLEANING

WIPE DOWN ALL CONTACT PARTS / EMPTY WASTE BUCKET

1. BUCKET - empty and wipe (insert overfill weight)
2. DRIP TRAY/CHUTE/NOZZLE - remove and clean
3. SANITATION BUCKET - place onto sanitation hook
4. WATER - flush
5. JUICE/SYRUPS - flush
6. BOTTLE STATION - wipe clean

ALSO CLEAN - FLOOR / DOOR / STORAGE SHELF

HYGIENE KIT



BOTTLE STATION

MORE THAN JUST WATER



FLUSH WATER / JUICE



DRIP TRAY & CHUTE



DRIP TRAY CHUTE IN FIRST

CLIP DRIP TRAY IN PLACE

WASTE BUCKET AND FULL WEIGHT

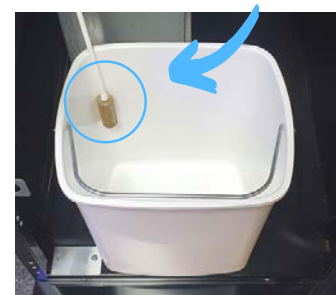

10. Cleaning and Hygiene

2.WEEKLY CLEANING

REMOVE HYGIENE PARTS AND THOUROUGHLY CLEANSE

1. BUCKET - empty and wipe (insert overfill weight)
2. DRIP TRAY/CHUTE/NOZZLE - remove and clean
3. SANITATION BUCKET - place onto sanitation hook
4. WATER - flush
5. JUICE/SYRUPS - flush
6. BOTTLE STATION - wipe clean
7. DISPENSE NOZZLES - remove from dispense head & clean
8. UV FILTER - check operational, flush - observe GREEN light
9. DRINK LEVELS - check these are correct

ALSO CLEAN - FLOOR / DOOR /STORAGE SHELF

HYGIENE KIT



BOTTLE STATION



FLUSH WATER / JUICE



DRIP TRAY & CHUTE



DRIP TRAY CHUTE IN FIRST

CLIP DRIP TRAY IN PLACE

WASTE BUCKET AND FULL WEIGHT

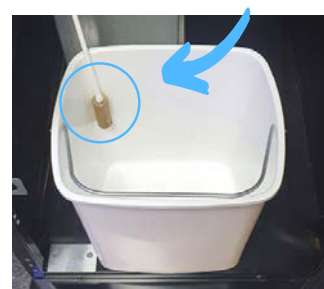

10. Cleaning and Hygiene

3. EVERY 6 MONTHS

YOUR SERVICE TECHNICIAN WILL NEED TO:

1. STERILISE - water lines (hydrogen peroxide or similar)
2. SANITISE - juice lines
3. REPLACE - UV Lamp (6 months or 8000 hours)
4. REPLACE - water filters
5. STRIP DOWN & STERILISE - **all contact and hygiene parts**
6. CLEAN - bottle dispense area / bucket / floor / door

HYGIENE KIT



BOTTLE STATION



FLUSH WATER / JUICE



DRIP TRAY & CHUTE



DRIP TRAY CHUTE IN FIRST

CLIP DRIP TRAY IN PLACE

WASTE BUCKET AND FULL WEIGHT



TEST ALL DRINKS & ADJUST IF NECESSARY

10. Cleaning and Hygiene

CLEANING WATER/JUICE LINES

SANITISING JUICE LINES:

- Remove bag in box connectors from juice box by half turning anti-clockwise and pulling off.
- Connect a relief valve to open the bag in box connector on the juice pipe. (Contact your juice supplier for a relief valve).
- Fill the sanitising bucket with warm water and hydrogen peroxide (or similar).
- Place ends of the juice lines into the bucket of solution and press and hold the flush button of each juice line in turn to pass fluid through until juice lines are primed full of sterilising fluid to the dispense nozzle.
- Leave for 15 minutes.
- Empty the sanitising bucket and replace with clean water.
- Flush the juice lines through until all traces of sterilising fluid have been removed and the water is pure clean and odour free.
- Remove the metal dispense nozzles and clean the spout thoroughly with the sterilising fluid and a small brush.
- Remove the relief valve and reconnect the bag back onto the juice box - half turn clockwise.
- Prime the juice lines using the push and hold flush button.

STERILISE WATER LINES:

- Flush with hydrogen peroxide solution (or similar).

TEST ALL DRINKS & ADJUST IF NECESSARY

11. Menu Programming Guide

USING THE BUTTONS

POST SOFTWARE UPDATE

- 1 Button 1 = UP
- 2 Button 2 = DOWN
- 3 Button 3 = CANCEL
- 4 Button 4 = ENTER



PRE SOFTWARE UPDATE

- 1 Button 1 = UP
- 2 Button 2 = DOWN
- 3 Button 3 = Quick = BACK
Long = SELECT
- ✗ Button 4 = NOT USED



ENTERING SERVICE CODES

When needed to enter a passcode (Service Mode):

- Button 1 = 1
- Button 2 = 2
- Button 3 = 3
- Button 4 = 4

LCD MENU PROGRAMMING

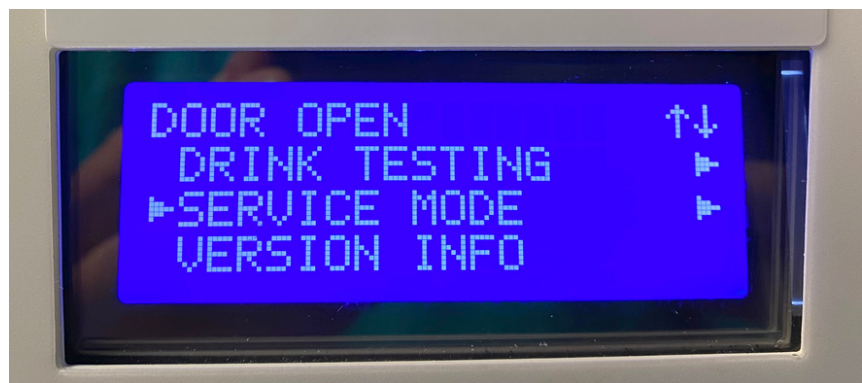

11. Menu Programming Guide

DOOR OPEN MODE

- This menu is accessed by opening the door.

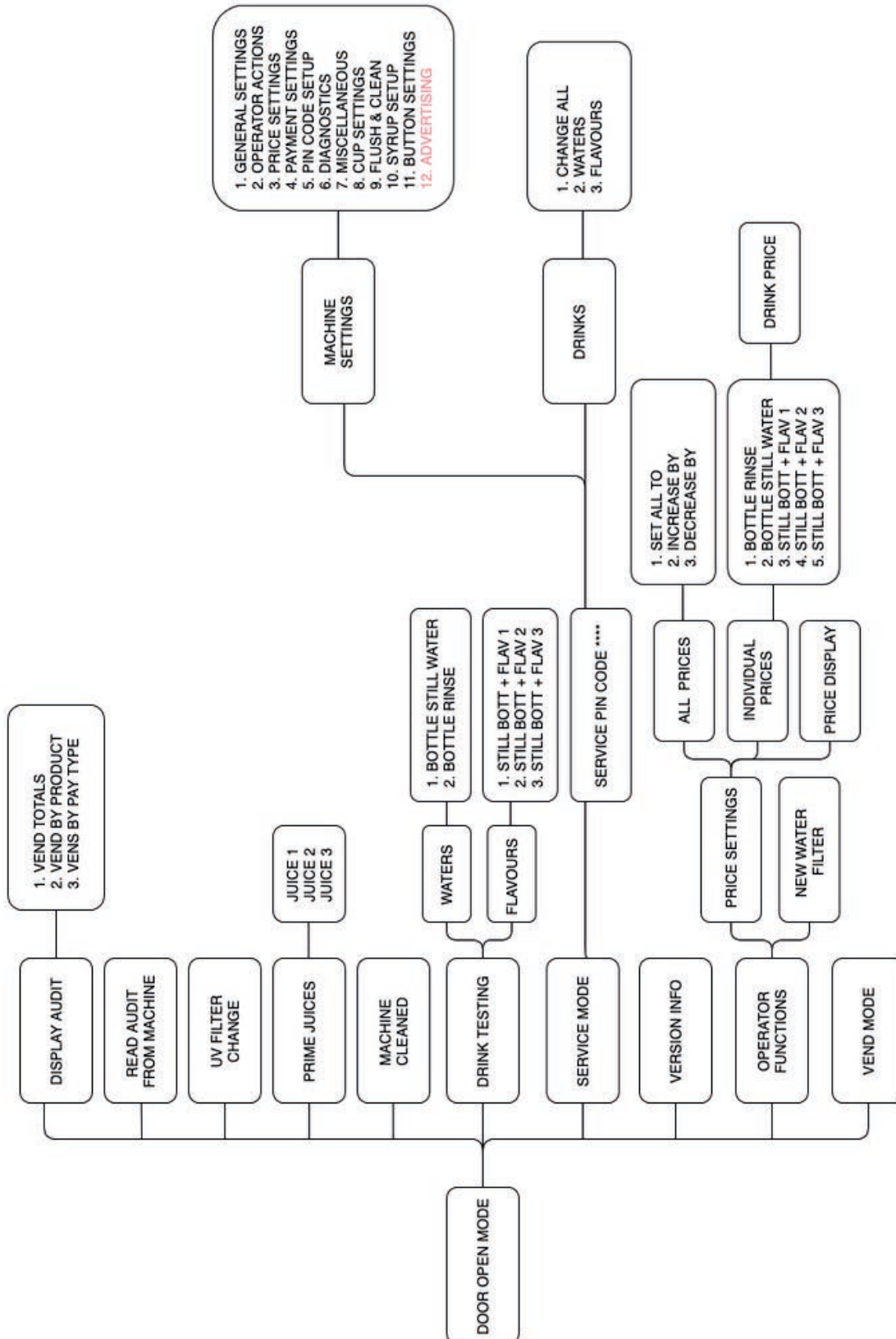

11. Menu Programming Guide

DOOR OPEN MODE

DISPLAY AUDIT:

- *Vend Totals* - total of ALL vends & date of last audit
- *Vend by Product* - shows vends by drink type & total revenue
- *Vend by Pay type* - shows vends by payment type - paid /free vend / test vends & total revenue for each.

READ AUDIT FROM MACHINE:

- Allows an Audit to be downloaded onto a formatted USB stick.

UV FILTER CHANGE:

- The UV Filter removes 99.99% of bacteria from the water
- When the UV filter has been changed, the counter must be reset to ensure the machine will keep dispensing.

PRIME JUICES:

- When replacing a juice/flavour you need to prime the product into the dispense tubes so its ready to dispense.
- This brings the product to the dispense head so it's ready to mix.

MACHINE CLEANED:

- This allows an operator / engineer to record that they have cleaned the machine.
- This can then be seen when reading the audit.

11. Menu Programming Guide

DOOR OPEN MODE

DRINK TESTING:

- Split into water and flavours.
- Used to test drinks and verify throw times and bottle fill levels.
- Bottle sensors are disabled during Drink Test Mode.

SERVICE MODE:

- Used to gain access to machine settings and drink recipes.
- Needs a code to access and only available for engineers / trained technicians.

VERSION INFO:

- Displays current software - from time to time Westomatic will need to run software upgrades to ensure machine functions optimally.

OPERATOR FUNCTIONS:

- The operator can access this function to change Drink Prices.
- Other functions can be configured and added into this area by an engineer in Service Mode.

VEND MODE:

- Allows you to use the machine as if the door was closed.
- Useful for checking the inner workings of the machine.
- Pushing the Door switch will revert back to door open mode.

11. Menu Programming Guide

SERVICE MODE

- This menu is accessed by entering service mode from the door open menu.
- Access PIN CODE 3211 (using hover select buttons 3, 2, 1)
- This is split into Machine Settings and Drink Settings

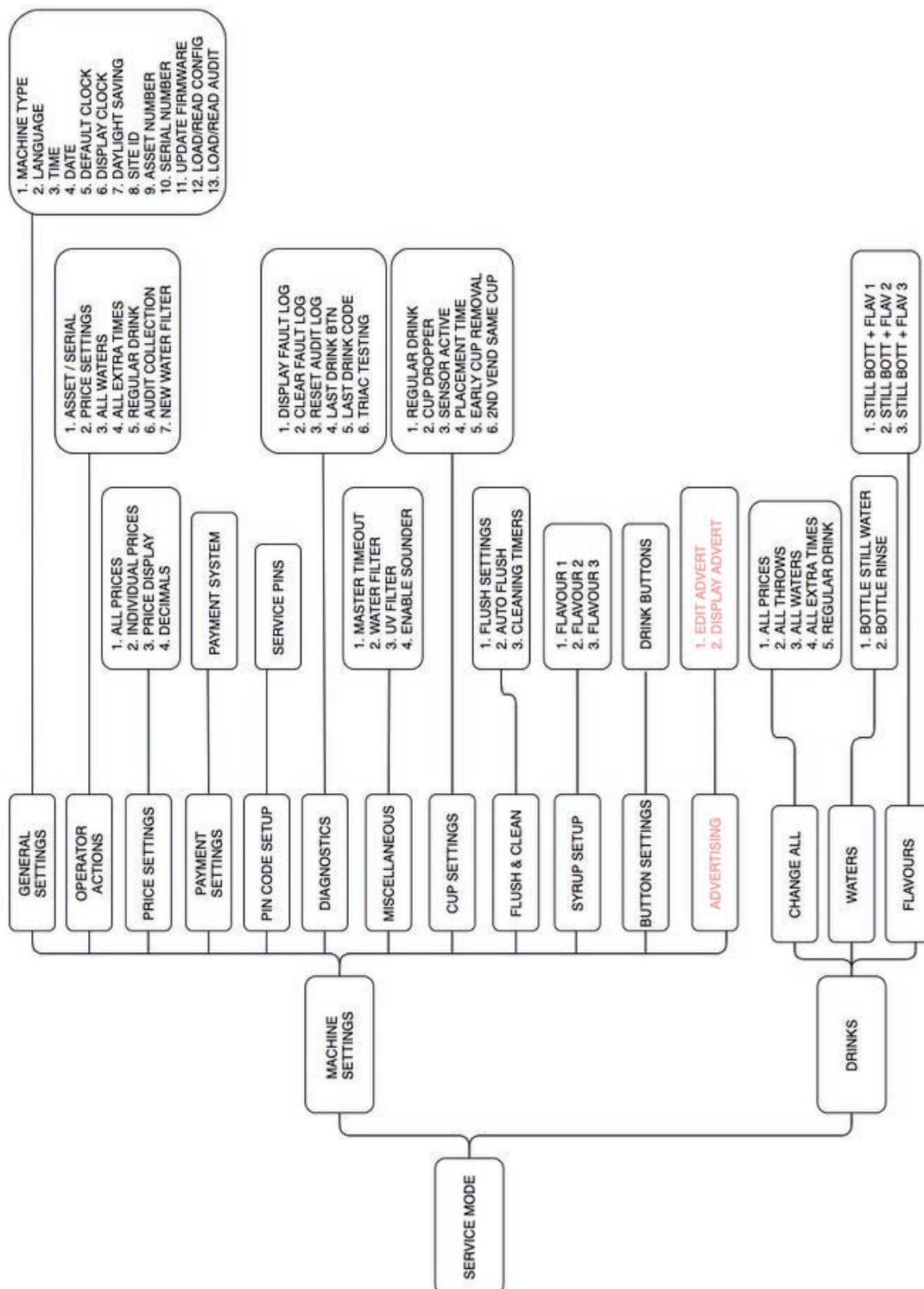

11. Menu Programming Guide

SERVICE MODE - MACHINE SETTINGS

- All menu parameters required to control the machine - allowing for customisation.

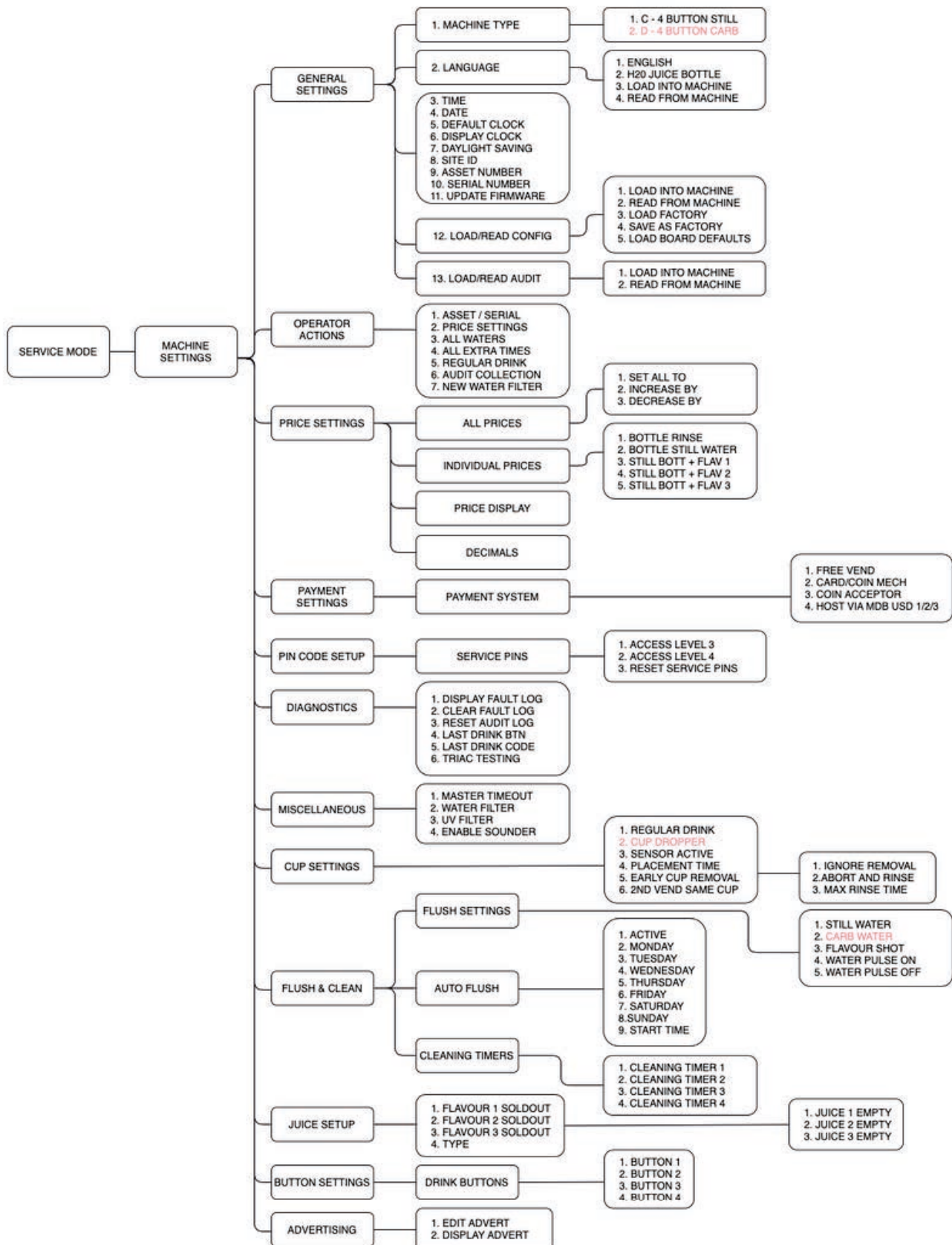

11. Menu Programming Guide

SERVICE MODE - MACHINE SETTINGS

GENERAL SETTINGS:

- Allows changes to various aspects of the machine such as time and date.
- *Machine Type* - set to 4 Button Still as standard.
- *Language* - allows certain language packages to be uploaded to the machine.
- *Time* - setting the time.
- *Date* - setting the date.
- *Default Clock* - sets time and date back to 00.
- *Daylight Savings* - sets to Automatic British Summer Time changes.
- *Site ID* - can be assigned to all machines on the same site - useful for auditing.
- *Asset Number* - is a machine reference number created by customer - useful for keeping track of service records etc.
- *Serial Number* - unique machine reference number assigned to the VMC of each machine control board at the time of manufacture at the Westomatic factory. The same serial number will also be visible on the serial plate located on the inside of the machine. The machine serial number will be required when requesting parts covered under the Westomatic Warranty agreement. **NOTE:** Once set the serial number cannot be erased or modified.
- *Update Firmware* - allows user to upload new firmware as and when it becomes available.

11. Menu Programming Guide

SERVICE MODE - MACHINE SETTINGS

- *Load / Read Config* - useful to download settings like keeping a backup. Also to load configuration settings onto the machine. It is possible to set the current customer settings to be the default factory settings. Loading board defaults sets the machine to Westomatic drink default settings - **this is not recommended**.
- *Load / Read Audit* - IMPORTANT - If the VMC board needs to be replaced all audit data will be lost - its useful to create a backup. This section allows Audit data to be read and reloaded onto a replacement board.

OPERATOR ACTIONS:

- Allows certain operator functions to be added to the Door Open menu (Operator Functions - currently only price settings there)
- *Asset / Serial Number* - gives access to this information
- *Price Settings* - operator can change price settings from door open mode
- *All Waters* - allows water levels across all drinks to be changed by %
- *All Extra Times* - all drinks include time to displace liquid - the valve closes but water remains in the system and drains outside normal vend time - extra times can be allowed at end of each vend to allow for drainage.

11. Menu Programming Guide

SERVICE MODE - MACHINE SETTINGS

- *Regular Drink - NOT USED*
- *Audit Collection* - allows operator to collect audit data
- *New Water Filter* - allows operator to replace and reset the filter settings.

PRICE SETTINGS:

- This menu will allow the user to set the pricing structure for a payment system if fitted. It is possible to price all drinks as one price or priced individually. Price increases can also be carried out as a percentage increase or decrease of either a generic price or an individual price.

PAYMENT SETTINGS:

- Allows user to set up payment system requirements.
- The machine can be set to free-vend or to accept a card reader.

PIN CODE SETTINGS:

- Allows service codes to be set up - this machine can set level 3 and 4 service codes for different levels of access to settings
- This is where you are able to reset service pin codes too

DIAGNOSTICS:

- A fault log records all events on the machine with a time and date stamp.

11. Menu Programming Guide

SERVICE MODE - MACHINE SETTINGS

- *Display Event Log* - all the events on the machine since the last time the log had been cleared.
- *Clear Log* - clears all events on the machine.
- *Reset Audit Log* - resets audit logs (do after download).
- *Last Drink BTN* - can read the last drink button pressed. This information can help with diagnostics.
- *Last Drink Code* - NOT USED.
- *Triac Testing* - Allows testing of TRIACS for power related diagnostics.

MISCELLANEOUS:

- Allows users to set timeouts for machine and water valve.
- *Master Timeout* - water valve timeout.
- *Water Filter* - water filter drink counter.
- *UV Filter* - UV Filter drink counter.
- *Enable Sounder* - enables / disables sound alerts.

CUP SETTINGS:

- Bottle settings and bottle sensor adjustments.
- *Regular Drink*- NOT USED.
- *Cup Dropper* - NOT USED.
- *Sensor Active* - used to enable or disable the bottle sensor to allow customers to use their own bottle.
- *Placement Time* - time between placing the bottle and pressing the drink selection button.

11. Menu Programming Guide

SERVICE MODE - MACHINE SETTINGS

- *Early Cup Removal* - instructs the VMC as to what you would like the machine to do when the customer removes the bottle before the end of a vend. Options include Ignore / Abort & Rinse / Max Rinse Time.
- *2nd Vend Same Cup* - NOT USED.

FLUSH & CLEAN:

- Allow the user to set up the flush times for each drink
- *Flush Settings* - max time settings can be altered based on the drink type - Still water / juice shot / water pulse on / water pulse off.
- *Auto Flush* - this can be set to up to 3 times per day, but is inactive as a default. Flushes each juice lines separately.
- *Cleaning Timers* - a timer can be set after a period of inactivity per flavour - for example Drink 1 has no activity for 1 hour - a timer can be set to flush the lines.

JUICE SETUP:

- This function allows customer to count the number of drinks per juice box/flavour.

BUTTON SETTINGS:

- These settings are pre-programmed for each drink settings.

ADVERTISING:

- Allows users to place a small text advert on the LCD screen.
- Better used via USB.

11. Menu Programming Guide

SERVICE MODE - DRINKS SETTINGS

- This is where all the drinks recipes are stored. Each drink can be individually configured to give the correct drink ratio of water to powder.

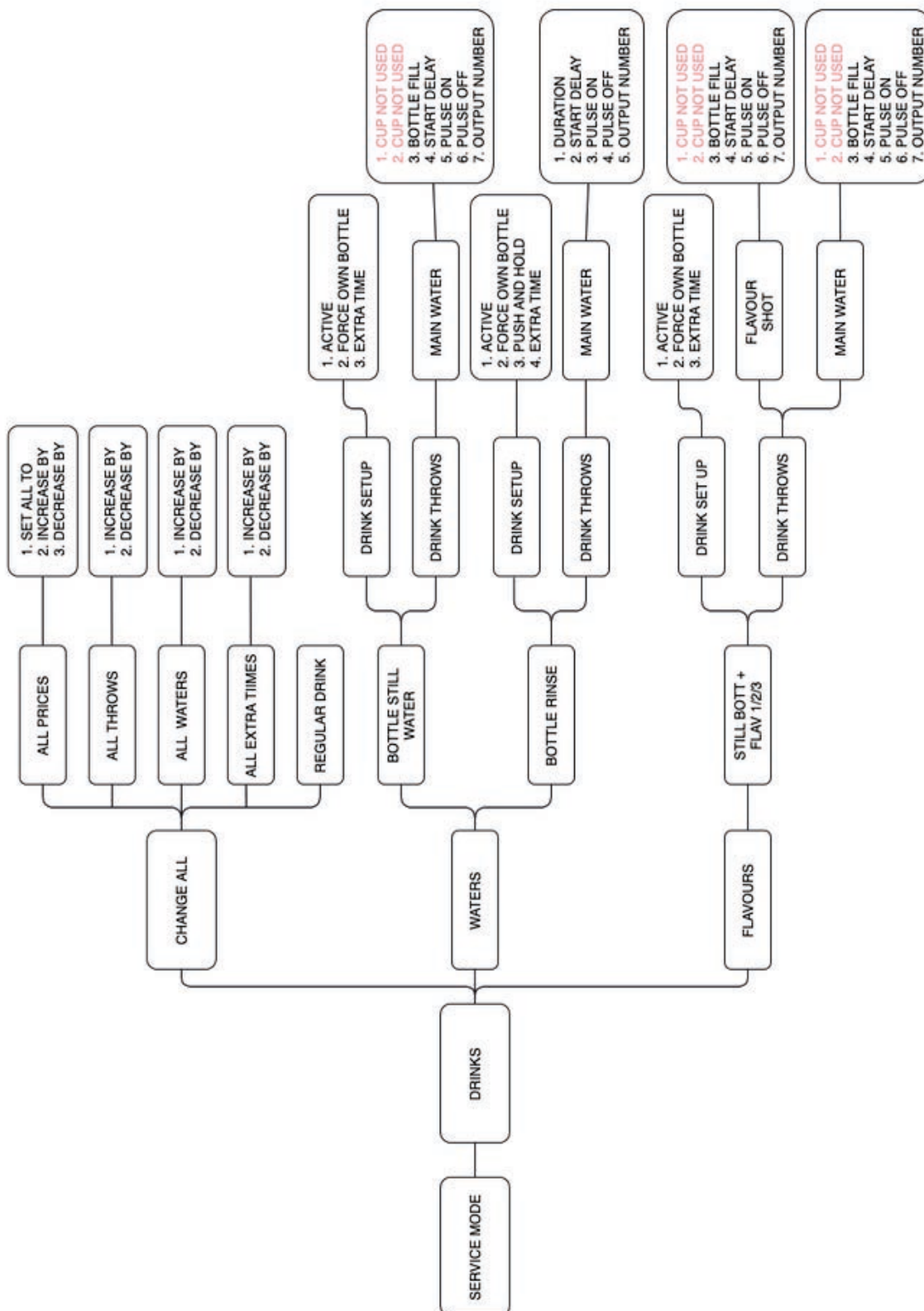

11. Menu Programming Guide

SERVICE MODE - DRINKS SETTINGS

CHANGE ALL:

- Changes all options instead of individually.
- *All Prices* - options to set all to / increase by / decrease by %.
- *All Throws* - options to increase by / decrease by %.
- *All Waters* - options to increase by / decrease by %.
- *All Extra Times* - options to increase by / decrease by %.
- *Regular Drink* - NOT USED.

WATERS:

- This is used to change the default water only drinks.
- *Bottle Still Water* - gives options to change and modify settings for still water including timings / start delay / pulse on / pulse off.
- *Bottle Rinse* - gives options for the rinse option, including the duration / start delay / pulse on / pulse off.

FLAVOURS:

- This is used to set up drink recipes.
- *Still Bottle + Flavour 1/2/3* -allows selection of each drink individually.
- *Drink Set Up* - where you can enable a drink for use and allow extra time at the end of a vend to allow final drips to enter the bottle. Force own bottle is set as standard, and extra time allows for the final drops.
- *Drink Throws* - enables the set up of the juice shot and water to make a drink.

11. Menu Programming Guide

SERVICE MODE - DRINKS SETTINGS

- *Flavour Shot* - allows changes to settings of dispense of the flavour shot. For the H2O Hydration Station - Cup settings are not used.
- *Bottle Fill* - the time the juice pump runs.
- *Start Delay* - refers to how much time between the start of the drink production and the dispense of the juice shot.
- *Pulse On / Off* - allows pulsing during the dispense of flavour shot.
- *Output number* - set as default on the VMC - no need to change.
- *Main Water* - allows changes to settings of dispense of the water. For the H2O Hydration Station - Cup settings are not used.
- *Bottle Fill* - the time the main water valve is open.
- *Start Delay* - delay time of main water valve opening.
- *Pulse On / Off* - allows pulsing of water on and off.
- *Output number* - set as default on the VMC - no need to change.

12. Water & UV Filters

CHANGING WATER FILTERS

CHANGE WATER FILTERS:

1. Turn water off at the Internal Isolation Tap and Flush any water from the Filter, using the flush button.
2. Power OFF the machine.
3. Disconnect Water filters by unscrewing from filter heads:
4. Micro-plastics - BLUE
5. Sediment - WHITE
6. Install new filters.
7. Slowly turn on the water isolation tap.
8. Connect the power and Switch machine on.
9. Prime the filters - by pressing the Flush button until the water runs smoothly (probably 3 or 4 times). CHECK FOR LEAKS.
10. Test All Drinks.



1

TURN
WATER
OFF

2

UNSCREW
FROM
FILTER
HEADS

12. Water & UV Filters

CHANGING UV FILTERS

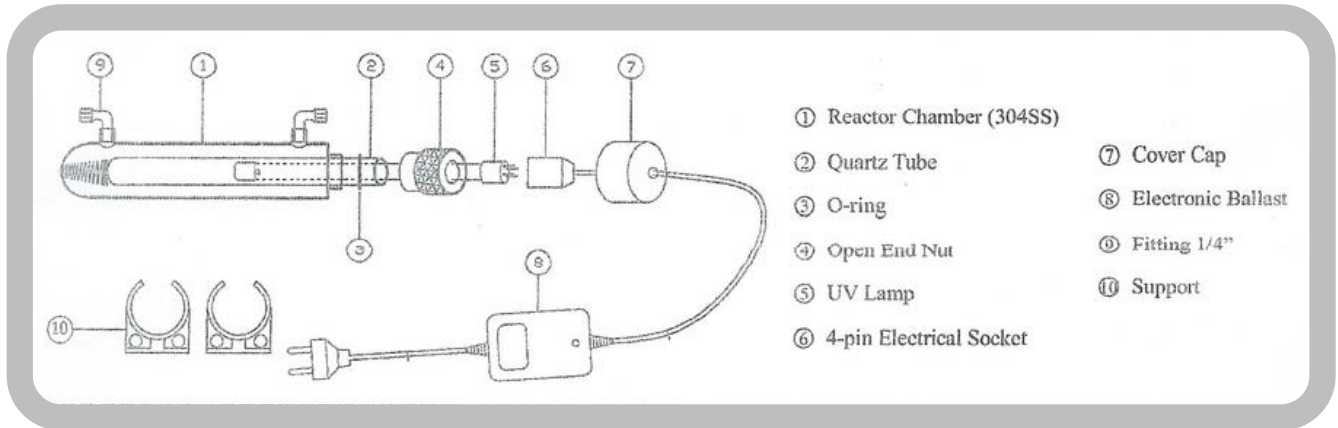

CHANGE UV FILTER:

1. Turn water off at the Internal Isolation Tap and Flush any water from the Filter, using the flush button.
2. Power OFF the machine.
3. Disconnect UV filter - remove filter from water in pipes, and disconnect the molex.
4. Install new filter and re-fit water pipes and reconnect molex.
5. Once all plumbing connections are fitted - slowly turn on the water via the isolation tap.
6. Connect the power to start up.
7. Flush water several times to clear any air or dust - CHECK FOR LEAKS.
8. Reset UV Filter on machine - Service Mode - Miscellaneous - UV Filter - Changed ACCEPT
9. Test All Drinks.

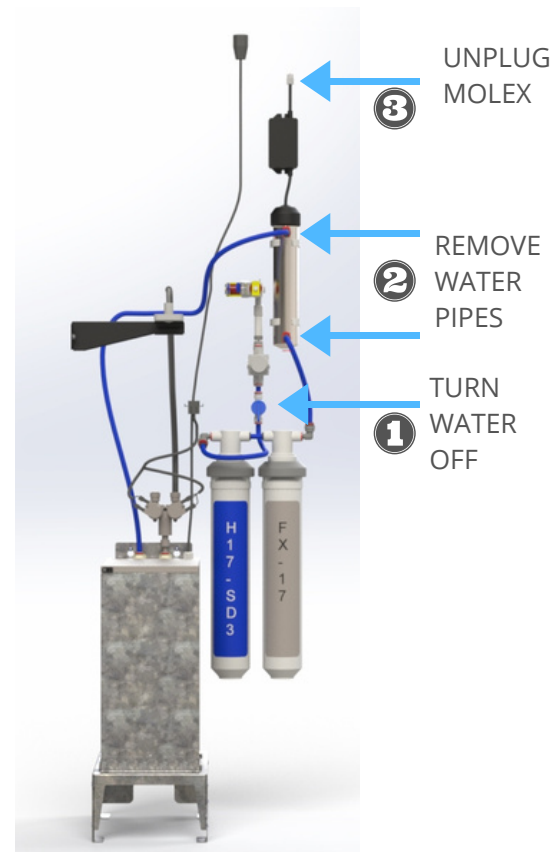

13. Control Processor & USB

ACCESSING THE BOARD



1. There is a USB port located on the inside of the door (near the bottle station) - that allows a USB memory stick to be easily plugged in.
2. Should you need access to the PCB board itself - there are 2 screws on the housing that remove the cover plate.
3. If changing the board - ensure any config/audit settings are downloaded FIRST as the information will be lost when a VMC is replaced.

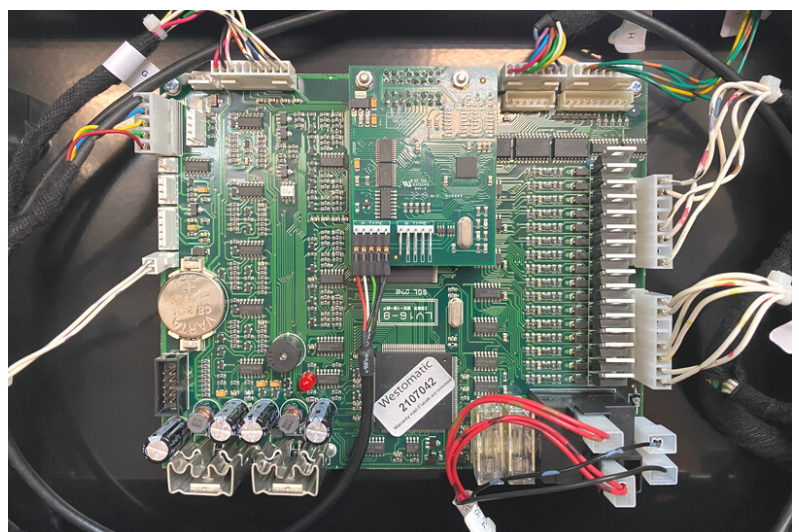
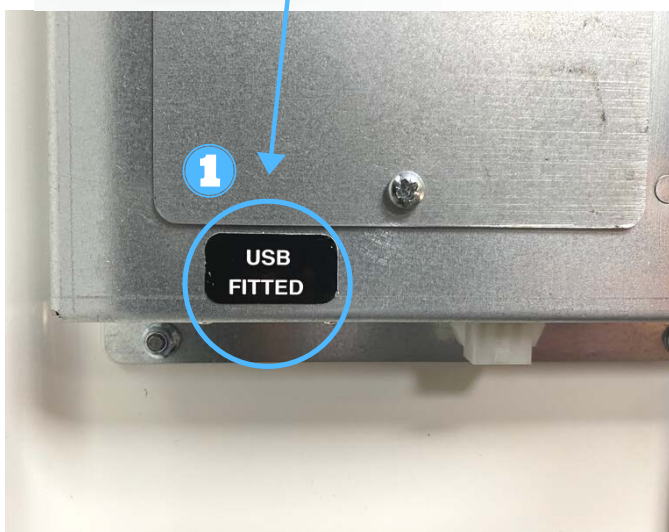

14. Audit Loading / Reading

AUDIT INFORMATION

IMPORTANT -

- Once the Audit has been Reset / Uploaded to USB, the information cannot be retrieved again on the machine display.
- All 'interim' counters will reset to zero ready for the next audit.

H2O DRINK CODES:

BOTTLE RINSE	AUDIT DRINK CODE = D01
STILL BOTT + FLAV 1	AUDIT DRINK CODE = D92
STILL BOTT + FLAV 2	AUDIT DRINK CODE = D94
STILL BOTT + FLAV 3	AUDIT DRINK CODE = D96
STILL BOTT + FLAV 4	AUDIT DRINK CODE = D05
BOTTLE STILL WATER	AUDIT DRINK CODE = D03

AUDIT EXAMPLE INFORMATION:

VED TOTALS	VENDS BY PRODUCT	VENDS BY PAY TYPE
Example :	Example :	Example :
Installed 00/00/00	BOTTLE RINSE	PAID Vends 0
Vends 0	Vends 0	Value 0.00
Value 0.00	Value 0.00	FREE Vends 0
Last audit 00/00/00	STILL BOTT + FLAV1	Value 0.00
Vends 0	Vends 0	TEST Vends 0
Value 0.00	Value 0.00	Value 0.00
	STILL BOTT + FLAV2	
	Vends 0	
	Value 0.00	
	STILL BOTT + FLAV3	
	Vends 0	
	Value 0.00	
	BOTTLE STILL WATER	
	Vends 0	
	Value 0.00	
	ETC..... Continue for All Drink Selections	

14. Audit Loading / Reading

READING AUDIT FROM MACHINE

- A formatted USB stick is required as per:



- Its **VERY IMPORTANT** that the file structure, and format is exactly the same as the above - including the capital letters.
- Open the machine door and insert the formatted USB stick into the USB port.
- The machine will recognise the insertion of the USB by beeping twice.
- From *LOAD/READ AUDIT* select *READ FROM MACHINE - ENTER*.
- The display will show:

```
READ FROM MACHINE
▶ AUTO SELECT
SELECT FILE
```

- Selecting **AUTO SELECT** will automatically create a new, sequential audit filename which when read/saved to the USB will contain all the audit data present at the time of saving.
- If *AUTO SELECT* is confirmed display will show:

```
READ FROM MACHINE
FILE: - A0000001.TXT
ACCEPT OR CANCEL?
```

14. Audit Loading / Reading

READING AUDIT FROM MACHINE

- Pressing ENTER to accept:

```
READ FROM MACHINE
FILE: - A0000001.TXT
READING...
```

- When the audit file has been read, the machine will beep and return to *LOAD/READ AUDIT* sub-menu.
- Exit back to *DOOR OPEN MODE*, remove USB and close the door.
- If SELECT FILE is confirmed , the following will display:

```
SELECT FILE
▶ A0000001.TXT
A0000002.TXT
```

- Scroll to the appropriate file, ENTER to accept & overwrite the existing file selected:

```
READ FROM MACHINE
FILE: - A0000001.TXT
ACCEPT OR CANCEL?
```

- Press *ENTER*:

```
READ FROM MACHINE
FILE: - A0000001.TXT
READING...
```

- When the audit file has been read, the machine will beep and return to *LOAD/READ AUDIT* sub-menu.
- Exit back to *DOOR OPEN MODE*, remove USB and close the door.

14. Audit Loading / Reading

LOADING AUDIT INTO REPLACEMENT CONTROL BOARD

- From the same USB used to retrieve the audit data with the following file structure:



- Its **VERY IMPORTANT** that the file structure, and format is exactly the same as the above - including the capital letters.
- Open the machine door and insert the formatted USB stick into the USB port.
- The machine will recognise the insertion of the USB by beeping twice.
- From *LOAD/READ AUDIT* select *LOAD INTO MACHINE - ENTER*.
- The display will show:

```
SELECT FILE
▶ A0000001.TXT
A0000002.TXT
```

- Scroll to pick the appropriate file - *ENTER*.

```
LOAD INTO MACHINE
FILE: - A0000001.TXT
ACCEPT OR CANCEL?
```

- Press ENTER:

```
LOAD INTO MACHINE
FILE: - A0000001.TXT
LOADING...
```

14. Audit Loading / Reading

LOADING AUDIT FROM MACHINE

- When the audit file has been read, the machine will beep and return to LOAD/READ AUDIT sub-menu.
- Exit back to DOOR OPEN MODE (ensures changes are saved).
- **SWITCH OFF** the machine - remove USB - **SWITCH ON** machine and close door.

15. Firmware & Configurations

UPLOADING NEW FIRMWARE

Occasionally new firmware becomes available and should be loaded into the machine.

- A formatted USB stick is required as per:



- Its **VERY IMPORTANT** that the file structure, and format is exactly the same as the above - including the capital letters.
- **Any Firmware Update provided must be copied into the Firmware folder.**
- Before update, read config & audit files and make note of the file numbers saved.
- Open the machine door and insert the formatted USB stick into the USB port.
- The machine will recognise the insertion of the USB by beeping twice.
- From *GENERAL SETTINGS* select *UPDATE FIRMWARE - ENTER*.
- The display will show all available firmware files:

```
UPDATE FIRMWARE
▶ AZURE V 03.06.0000
```

- Scroll to select the file to load, and *ENTER*.

15. Firmware & Configurations

UPLOADING NEW FIRMWARE

- The display will show:

```
FOUND USB MEMORY  
AZURE.FMW  
LOADING...XX%*
```

- The firmware upload will take approx 60 seconds after which the machine will automatically reboot.

15. Firmware & Configurations

LOADING / READING CONFIG

Occasionally it may also be necessary to change the machines configuration settings and save them to a USB stick, or to transfer these settings to another machine.

- A formatted USB stick is required as per:



- Its **VERY IMPORTANT** that the file structure, and format is exactly the same as the above - including the capital letters.

LOAD INTO MACHINE:

- Open the machine door and insert the formatted USB stick into the USB port.
- The machine will recognise the insertion of the USB by beeping twice.
- From LOAD/READ CONFIG select *LOAD INTO MACHINE - ENTER*

SELECT FILE

▶ AZUR_XYZ.CFG

- Scroll to select the file to load, and *ENTER*.
- The display will show:

LOAD INTO MACHINE
FILE: - AZUR_XYZ.CFG
ACCEPT OR CANCEL?

15. Firmware & Configurations

LOADING / READING CONFIG

- Pressing *ENTER* to accept will show:

```
LOAD INTO MACHINE  
FILE: - AZUR_XYZ.CFG  
LOADING...
```

- When config upload is complete the machine will emit a beep.
- Exit out of the *LOAD/READ CONFIG* back to *DOOR OPEN MODE* (This saves the settings)
- **SWITCH OFF** Machine - remove the USB - **SWITCH ON** machine, and close the door.

READ FROM MACHINE:

- Open the machine door and insert the formatted USB stick into the USB port.
- The machine will recognise the insertion of the USB by beeping twice.
- From *LOAD/READ CONFIG* select *READ FROM MACHINE - ENTER*

```
READ FROM MACHINE  
▶ AUTO SELECT  
SELECT FILE
```

- Selecting *AUTO SELECT* - will cause the machine to automatically create a new, sequential config filename which when read/saved to the USB will contain all the config settings.

```
READ FROM MACHINE  
FILE: - AZUR_XYZ.CFG  
ACCEPT OR CANCEL?
```

15. Firmware & Configurations

LOADING / READING CONFIG

- Pressing *ENTER* to accept will show:

```
READ FROM MACHINE  
FILE: - AZUR_XYZ.CFG  
READING...
```

- When config upload is complete the machine will emit a beep.
- Exit out of the *LOAD/READ CONFIG* back to *DOOR OPEN MODE* (This saves the settings)
- Remove the USB and close the door.
- If *SELECT FILE* is confirmed - The display will show all available config files:

```
SELECT FILE  
▶ AZUR_XYZ.CFG  
AZUR_ABC.CFG  
AZUR_DEF.CFG
```

- Scroll to select the appropriate file, *ENTER*:

```
READ FROM MACHINE  
FILE: - AZUR_XYZ.CFG  
ACCEPT OR CANCEL?
```

- Select *ENTER*:

```
READ FROM MACHINE  
FILE: - AZUR_XYZ.CFG  
READING...
```

15. Firmware & Configurations

LOADING / READING CONFIG

- When config upload is complete the machine will emit a beep.
- Exit out of the LOAD/READ CONFIG back to DOOR OPEN MODE (This saves the settings)
- Remove the USB and close the door.

15. Firmware & Configurations

LOADING / READING CONFIG

SAVE AS FACTORY:

- This function allows the user to overwrite the Westomatic factory default config settings - WVS cannot accept responsibility for any machine malfunction/drink quality due to changing the settings.
- From *LOAD/READ CONFIG* sub menu select *SAVE AS FACTORY - ENTER*:

SAVE AS FACTORY
ACCEPT/CANCEL

- Press *ENTER*:

SAVE AS FACTORY
ARE YOU SURE?

- Press *ENTER*:

SAVE AS FACTORY
BUSY

- Pressing *ENTER* will cause the default factory config settings to be overwritten by the new user config settings
- The machine will automatically re-boot and revert to *DOOR OPEN MODE*.

16. Spare Parts

USEFUL SPARE PARTS

DESCRIPTION	PART NUMBER
SOLENOID VALVE ASSEMBLY	201791
BOTTLE SENSOR ASSEMBLY	2100014
FUSE & DISTRIBUTION BOX	2100017
SWITCH F&D	1052009
FUSE – T3.15AMP 32 x 6.3 HBC	1025002
FUSE – T1.00AMP 32 x 6.3 HBC	1025011
FUSE – T1.60AMP 32 X 6.3 HBC	1025015
FUSE – T2.50AMP 32 x 6.3 HBC	100012075
HOVER SELECT BUTTON	2100005
H2O CPU, PCB WITH H2O SOFTWARE	1042017
HIGH SPEED USB INTERFACE – IO BOARD	1042018
12" WIDESCREEN DIGITAL SCREEN	1042048
4GB SD MEMORY CARD	1042035
LCD DISPLAY	1042002
UV FILTER KIT (NEW STYLE)	2100047
H2O – WATER FILTER (MICROPLASTICS)	1024023
H2O – WATER FILTER (SEDIMENT)	1024024
WATER REGULATOR 0-8 BAR	1047001
SYRUP PUMP	1046002
H2O HYGIENE KIT	2100003
TUBING – 4mm x 2mm	1029006
NOZZLE – DISPENSE TUBE	1029037
HOSE INLET (1.5mm)	1029032
TUBING CLEAR PVC 6mm x 9mm	1029037
NOZZLE TUBE CLUSTER	1029040
STEM ELBOW 3/8" x 3/8"	1029043
BUCKET 15L WASTE	1039001
H2O - LOCK & 2 KEYS	2100011
H2O - <u>KEY</u> X1	1034020
PIPE STIFFENER	1023253
CUP LOCATION GUIDE	1037565
DRAIN TRAY	1037566
KNURLED NUTS	1023293
H2O – WVS STANDARD DECALS - WATER	1027122
H2O – WVS STANDARD DECALS - JUICE	1037682
NO TOUCH STICKER	1037686
CASHLESS BLANKING PLATE	1037596

ORDER DIRECT FROM WESTOMATIC:

 +44 (0) 1626 323100

 support@westomatic.com

Liability & Warranty

LIABILITY

- All details and indications for the operation, maintenance and cleaning of this Evolve Nutrition dispenser have been made under consideration of our knowledge and experiences collected up to now.
- Westomatic Vending Services Ltd. reserves the right to make technical changes to this machine type without notice as a result of continuous product development.
- Text translations are made to the best of Westomatic Vending Services Ltd.'s knowledge. However, we exclude any liability for translation errors. The English version of the operation instructions shall prevail for warranty purposes.
- It is advised that the user manual instructions must be carefully read before machine installation or operation is started. Westomatic Vending Services Ltd. does not bear any liability for any damages or disturbances resulting from non-observance of the User Manual or Operator Instructions.
- It is strictly forbidden to make this user manual or the operator instructions accessible to any third party. Non-observance will result in a claim for damages.

SPARE PARTS

- Only genuine, original Westomatic Vending Services Ltd. spare parts should be used when servicing the machine.
- Part Sales telephone: **+44 (0) 1626 323100** or email **support@westomatic.com**

ATTENTION!

Faulty or defective non-Westomatic spare parts may lead to incorrect machine operation or damage. In the case where non-Westomatic spare parts are used, all obligations of Westomatic Vending Services Ltd. such as warranties, service contracts etc. are void without prior notice & agreement.

WARRANTY

- A **THREE YEAR** warranty on parts only is offered on new, free-standing machines, from the date of invoice, subject to our warranty procedures having been followed.
- This **EXCLUDES** all plastic components, delivery hoses, outlet nozzles (which we recommend are changed every 6 months) & all other parts with a sales value of less than £15.
- All parts claimed under our Warranty Terms must be returned to our Head Office - Units 7-8 Block 4 Forde Court, Forde Road, Newton Abbot, Devon, TQ12 4BT - for Repair / Replacement or Credit at our discretion **within 30 DAYS** of notifying us of a claim.
- A **FIVE YEAR** warranty is offered as standard for companies who have achieved Westomatic Diamond Distributor status .

Technical Specifications

MACHINE SPECIFICATIONS

GENERAL: WEIGHT: 101kg
DIMENSIONS: (H)1825 x (W)500 x (D)700 mm (inc Door)
NOISE: 70dB (will not exceed)

ELECTRICAL: VOLTAGE: 230 - 240 Volts AC
CURRENT: 12
POWER: 0.5 Kilowatts
FREQUENCY: 50Hz
INTERNAL: 24 Vdc (internal components) / 12 Vdc (digital media)
FREQUENCY: 50Hz
INTERNAL MOTOR: 24Vdc
WATER INGRESS PROTECTION: IPX0

WATER: SUPPLY: 15mm BSP from rising main
MIN PRESSURE: 138 kpa / 20 p.s.i / 1.38 Bar
MAX PRESSURE: 828 kpa / 120 p.s.i / 8.28 Bar
STANDING: 100 - 125 kpa / 14.5 -18.1 p.s.i / 1.00 - 1.25 Bar

DISPENSE PHASE: 140 (watt/hour)
PER LITRE: 30 - 43 (watt/hour/litre)
IDLE PHASE: 41.39 (watt/hour)

REFRIGERATION: REFRIGERANT TYPE: R134a
REFRIGERANT QUANTITY: 80g

FUSE RATINGS

FUSE	CIRCUIT DESCRIPTION	6.3 x 32MM CERAMIC FUSES
F1	Chiller Supply	T 3.15 AMP
F2	U.V Filter	T 1.00 AMP
F3	Power Supply	T 1.60 AMP
F4	Door LED Lights & Screen	T 3.15 AMP
F5	24Vdc Supply	T 3.15 AMP

Certification



(EC Machinery Directive 89/392/EEC) as amended...

Declaration of Conformity

This is to certify that the:

H2O Hydration Station

Comprising the following models.

Payment System
Non-Payment System

Manufactured by:

Westomatic Vending Services Ltd, Units 7-8 Block 4 Forde Court, Forde Road, Brunel Industrial Estate,
Newton Abbot, Devon, TQ12 4BT
Tel.01626 323100 - Fax 01626 332828

Conforms to the protection requirements of council Low Voltage Directive 73/23/EEC as amended 93/68/EEC relating to Electromagnetic Compatibility, by application of:

EMC Test Standards:

EN 55014-1:2000 + A1:2001 + A2:2002 :

Conducted emissions (0.15MHz-30MHz)

Discontinuous conducted emissions Disturbance Power (30MHz-300MHz)

EN 55014-2:1997 + A1:2001 (Category II)

ESD,EFT/Bursts , Surges ,Conducted immunity (0.15MHz-230MHz), Dips and interruptions

EN 61000-3-2:2000

Mains harmonics

EN 61000-3-3:1995 + A1:2001

Voltage fluctuations

EMF Test Standards:

EN 50366:2003

Electromagnetic fields.

Electrical Safety Test Standards:

EN 60335-1:2002 + A1:2004 + A11:2004 + A12:2006

Household and similar electrical appliances - Safety - Part 1 - General requirements

EN 60335-2-75:2004 + A1:2005

Household and similar electrical appliances - Safety - Part 2-75 -Particular requirements for commercial dispensing appliances and vending machines

Supplementary Information :

- [A] : Included mains filtering.
[B] : Product to be installed in accordance with manufactured instructions.
[C] : Class of protection against electrical shock. : Class I

I, the undersigned, hereby declare that the equipment specified above conforms to the above Directive and Standards. For and on behalf of Westomatic Vending Services, March 2008.

Richard Brinsley