



NEO + VENDING MACHINE



OPERATORS GUIDE – Revision 1

NEO + VENDING MACHINE

CONTENTS

page

| | |
|--|-------------------------------------|
| SPECIFICATIONS | 4 |
| SERVICES REQUIRED | 4 |
| Electrical Supply | 4 |
| Water Supply | 4 |
| SAFETY WARNINGS | 5 |
| FROST WARNING | 6 |
| HOT WATER WARNING | 6 |
| INSTALLATION | 7 |
| Location..... | 7 |
| Levelling | 7 |
| Connecting the Water Services | 8 |
| Connecting the Electrical Services | 9 |
| HYGIENE | 10 |
| Daily HYGIENE..... | 11 |
| Flushing the Machine..... | 11 |
| WASTE BUCKETS | 11 |
| Cleaning the Mixing Systems | 12 |
| WEEKLY HYGEINE..... | 14 |
| Cleaning the Tea Brewer | 14 |
| Refitting the Tea Brewer | 16 |
| Cleaning the Coffee Brewer Units | Error! Bookmark not defined. |
| Cleaning | Error! Bookmark not defined. |
| Extract Duct Cleaning | 22 |
| Filling..... | 23 |
| Instant Products | 23 |
| Bean Hopper | 23 |
| ACCESSING THE USER PROGRAMS | 24 |
| Set Pricing Mode..... | 24 |
| Change Prices | 24 |

FOREWORD

The information contained in this technical manual is applicable to Neo +. Due to customer requirements some units may vary from the one described in the manual.

Only personnel who have undergone relevant equipment training must undertake maintenance of the dispensing machine.

The Manufacturer reserves the right to make changes, without notice, to the design of the dispensing machine, which may affect the information, contained in this manual.

The Step and Neo Beverage Machine is designed for indoor use, in an environment with an ambient temperature range of between 1°C and 40°C.

THIS APPLIANCE CAN BE USED BY CHILDREN AGED FROM 8 YEARS AND ABOVE AND PERSONS WITH REDUCED PHYSICAL, SENSORY OR MENTAL CAPABILITIES OR LACK OF EXPERIENCE AND KNOWLEDGE IF THEY HAVE BEEN GIVEN SUPERVISION OR INSTRUCTION CONCERNING USE OF THE APPLIANCE IN A SAFE WAY AND UNDERSTAND THE HAZARDS INVOLVED. CHILDREN SHALL NOT PLAY WITH THE APPLIANCE. CLEANING AND USER MAINTENANCE SHALL NOT BE MADE BY CHILDREN WITHOUT SUPERVISION.



NEO + BEVERAGE MACHINE

SPECIFICATIONS

| | |
|--------------|-----------------------|
| Weight: | 160kg |
| Height: | 183cm |
| Width: | 69.8cm |
| Depth: | 69.8cm |
| Temp. Range: | 1°C to 40°C (ambient) |

SERVICES REQUIRED

Electrical Supply

| | |
|-----------------|--|
| Supply voltage: | 230V~, 50Hz, single phase fused supply |
| Current rating: | 16A |

The fused electrical supply must be terminated at a safety isolator switch, which provides a contact separation of at least 3mm. The isolator should be located within 1m of the beverage machine.

Water Supply

15mm dia. water mains supply, terminating at a convenient stop tap located within 1m of the beverage machine with an appropriate water blocker mounted between the machine and water source. The water supply should be fitted with appropriate water blocker.

Water Pressure

| | |
|----------|---------|
| Minimum: | 0.1 MPa |
| Maximum: | 0.8 MPa |

A 15mm double backcheck valve, with inspection port, should be fitted prior to the flexible hose.

SAFETY WARNINGS

1. The vending machine contains moving parts and utilizes very hot water both of which have the potential to cause injury. The machine should be switched off before undertaking any activity on the mixing or brewing systems, which requires the removal of any component part from the machine.
2. Maintenance of the beverage machine is only to be undertaken by trained personnel who are fully aware of the dangers involved and who have taken adequate precautions.
3. Lethal voltages are exposed when the mains electrical supply to the beverage machine is available and any of the following items are removed:
 - Left- or right-hand side boiler cover
 - Illuminated Door panel.

Maintenance personnel must ensure that the machine is isolated from the mains electrical supply before removing any of these items.

4. Replacement of the Type Y mains cable requires special tools. Should the cable become damaged only a trained person from an approved service agent must carry out the replacement.
5. THIS APPLIANCE MUST BE EARTHED.
6. Ensure that the connection to the water system is compliant with the pertinent national and local legislation. In the UK the Model Water Bylaws 1986 Statutory Instrument (SI) No. 1147 are applicable.
7. Ensure that the unit is positioned such that the plug connecting the unit to the mains supply is accessible.
8. The beverage machine is designed for indoor use, in an environment with an ambient temperature range between 1°C and 40°C. The machine should be located close to the appropriate electrical and water services with a minimum of 100mm (4in) clearance between the rear of the cabinet and the wall to allow adequate ventilation, and, if in a corner location, not

closer to the right hand wall than 400mm (16in) to accommodate the opening of the door.

9. The unit should not be situated in an area where a water jet could be used.
10. The vending machine is a heavy item. Ensure sufficient persons and suitable equipment are available when attempting to move it.
11. The water in the boiler, and the boiler itself, are hot enough to scald burn, even some time after the machine has been switched off. The boiler must be drained, filled with cold water and drained again before any attempt is made to handle it or any of its associated parts.
12. Young children, the aged and infirm should not be allowed to operate the beverage machine unsupervised, in order to protect them from the risk of being scalded by hot beverages.

FROST WARNING

Care must be taken to protect the machine from frost. Do not attempt to operate the machine if it becomes frozen. Contact the nearest service agent immediately. Do not restore the machine to operational use until it has been checked and approved for use by the service agent.

HOT WATER WARNING

CAUTION

The water available from the option shower head cleaning attachment is hot enough to scald or burn. Appropriate care must be taken when using this attachment.

Note: initially the water flowing from the attachment will be cool but will rapidly become extremely hot.

INSTALLATION

WARNINGS

- (1) THE BEVERAGE MACHINE IS A HEAVY ITEM. CARE MUST BE TAKEN WHEN LIFTING IT.
- (2) THE BEVERAGE MACHINE MAY TOPPLE IF THE MOUNT IS WEAK OR INSECURE. ENSURE THAT THE MOUNT IS SECURE AND THAT IT CAN SUPPORT THE WEIGHT OF THE MACHINE.
- (3) ENSURE THAT THE MAINS ELECTRICAL SUPPLY IS ISOLATED BEFORE CONNECTING THE SUPPLY CABLE TO THE MACHINE.

Location

The beverage machine is designed for indoor use, in an environment with an ambient temperature range of between 1°C and 40°C. The machine should be located close to the appropriate electrical and water services with a minimum of 100mm (4in) clearance between the rear of the cabinet and the wall to allow adequate ventilation, and, if in a corner location, not closer to the right hand wall than 400mm (16in) to accommodate opening of the door.

The unit should not be situated in an area where a water jet could be used.

Levelling

The machine should be levelled both fore and aft and side-to-side by adjustment of the four leveling feet, using a spirit level on the top of the cabinet to check its level.

The unit must be mounted within 10° of the vertical for safe operation.

CONNECTING THE WATER SERVICES

Refer to the current requirements of The Model Water Bylaws 1986 Statutory Instrument (SI) No.1147.

IF THE EQUIPMENT WAS SUPPLIED WITH A MAINS WATER HOSE, THIS HOSE SHOULD BE USED. DO NOT USE A HOSE FROM A PREVIOUSLY INSTALLED PRODUCT EVEN IF IT WOULD FIT. TO DO SO COULD LEAD TO A HEALTH HAZZARD.

The water supply should be taken from a 15mm rising main at a pressure of between 0.1 and 0.8 MPa and should be fitted with a stopcock to isolate the supply during servicing. A 15mm double backcheck valve, with inspection port, should be fitted to the flexible hose.

The outlet should be fitted with BSP connections and must be positioned within 1.5m of the machine to ensure correct fitting of the hose. If possible, the outlet should be located behind the machine to prevent misuse.

Before connecting the machine hose to the mains outlet, flush the system, via the stopcock, to remove any impurities that may have accumulated in the mains supply pipe.

Connect the machine hose to the mains outlet using the seals supplied and ensure that all fittings are tight. Turn on the water supply at the stopcock and check for leaks, both behind and inside the machine. The water supply should be fitted with the appropriate water blocker

Connecting the Electrical Services

WARNINGS

- (1) THE MACHINE MAINS CABLE MUST BE CONNECTED TO THE SUPPLY VIA A SAFETY ISOLATOR SWITCH WHICH PROVIDES A CONTACT SEPARATION OF AT LEAST 3mm.
- (2) REPLACEMENT OF THE Y TYPE MAINS CABLE REQUIRES SPECIAL TOOLS. SHOULD THE CABLE BECOME DAMAGED, REPLACEMENT MUST ONLY BE CARRIED OUT BY A TRAINED PERSON FROM AN APPROVED SERVICE AGENT.
- (3) ENSURE THAT THE SUPPLY TO THE ISOLATOR SWITCH IS ISOLATED BEFORE MAKING ANY CONNECTIONS TO IT.
- (4) ENSURE THAT THE SUPPLY TO THE MACHINE IS ISOLATED BEFORE MAKING ANY CONNECTIONS TO THE TERMINAL BLOCK AT THE REAR OF THE MACHINE.
- (5) THE DISPENSING MACHINE MUST BE EARTHED.

Connect the beverage machine, via a safety isolator switch with a contact separation of at least 3mm, to a 230V~, 50Hz, 13A supply. Note that replacement of the Y Type mains cable requires special tools. Should the cable become damaged, replacement must only be carried out by a trained person from an approved service agent.

Preferably, the isolator switch should be located behind the machine to prevent accidental damage or misuse.

Fuse Layout & Function

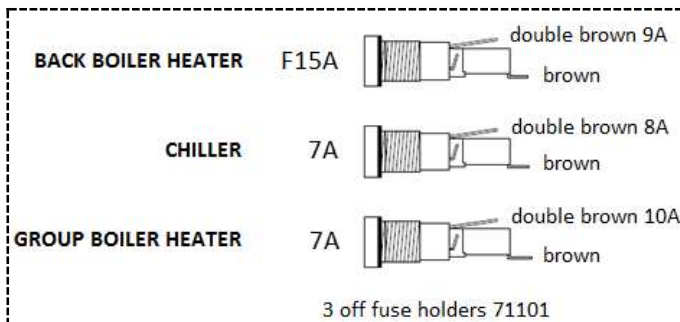

HYGIENE

WARNINGS

- (6) (THE NEO TOUCH IS FITTED WITH A GRINDER)

THE COFFEE GRINDER HAS SHARP BLADES THAT MAY CAUSE SEVERE INJURY TO ANY BODY PARTS THAT COME INTO CONTACT WITH THEM WHILST THEY ARE ROTATING. THE COFFEE CANISTER MAKES THE BLADES INACCESSIBLE IN NORMAL OPERATION. THEY ARE PREVENTED FROM OPERATING WHEN THE COFFEE CANISTER IS REMOVED BY AN ELECTRICAL INTERLOCK.

- (7) NO ATTEMPT SHOULD BE MADE TO DEFEAT THE INTERLOCK SWITCH.

- (8) IN THE EVENT THAT THE GRINDER BECOMES JAMMED DO NOT BE TEMPTED TO TRY TO REMOVE THE ITEM CAUSING THE JAM AS YOU MAY DAMAGE THE BLADES. IN THE EVENT THAT THE GRINDER BECOMES JAMMED CONTACT AN APPROVED SERVICE AGENT.

- (9) THE COFFEE BREWER HAS MOVING PARTS THAT MAY TRAP OR PINCH. ENSURE THAT THE INTERNAL SWITCH IS IN THE DISABLED POSITION BEFORE ATTEMPTING ANY ACTIVITY ASSOCIATED WITH THE BREWER UNIT. TO AVOID INJURY DO NOT PLACE FINGERS BETWEEN THE BREWER CHAMBER AND CARRIAGE AT ANY TIME.

- (10) AFTER ENABLING THE MACHINE USING THE INTERNAL SWITCH THE BREWER UNIT WILL START WITHOUT WARNING AND WILL ROTATE TO LOCATE ITS HOME POSITION. KEEP HANDS CLEAR OF THE BREWER UNIT UNLESS THE MACHINE IS SWITCHED OFF

- (11) THE UNIT MUST NOT BE CLEANED USING A WATER JET OR SPRAY. THE ENCLOSURE IS NOT WATERPROOF AND DAMAGE MAY OCCUR IF EXCESSIVE VOLUMES OF WATER ARE USED IN THE CLEANING PROCESS.

DAILY HYGIENE

FLUSHING THE MACHINE

Ensure that the following flushing instructions are carried out at least once a day and that mixing system and brewer cleaning is carried out at least once a week.

To Flush Machine:

- (1) Open machine as instructed and ensure machine is switched on.
- (2) Press the flush button. The machine will flush all the whipper and mixing bowl assemblies with clean hot water.
- (3) Repeat as necessary.
- (4) Once flushing has ceased, the machine will be ready for use.

To Flush Brewer(s):

- (5) Open machine as instructed and ensure machine is switched on.
- (6) Ensure that hands and loose clothing are clear of the brewer.
- (7) Press the brewer flush button. The machine will flush the brewer(s) with clean hot water.
- (8) Repeat as necessary.
- (9) Once flushing has ceased, the machine will be ready for use.

WASTE BUCKETS

- (1) Open the machines door and turn the machine off.
- (2) Once this is done you can remove the front wastewater bucket and dispose of the liquid.
- (3) Then remove the rear bucket, remove the waste bag containing waste coffee and tea grouts, dispose of the bag and fit a new one. Once done refit all buckets

CLEANING THE MIXING SYSTEMS

- (1) Open the door of the machine and switch machine off using the main switch.
- (2) Rotate the canister nozzles then remove the ingredient canisters. Wipe clean the exterior surfaces of the canister assembly and dry thoroughly.
- (3) Disconnect the pipes from the mixing bowls and remove the dispense nozzles from the dispense head. Wash and dry these items.
- (4) Rotate and lift off the whipper steam hood ①
- (5) For each mixing system in turn remove the mixing system ② by pulling towards yourself.

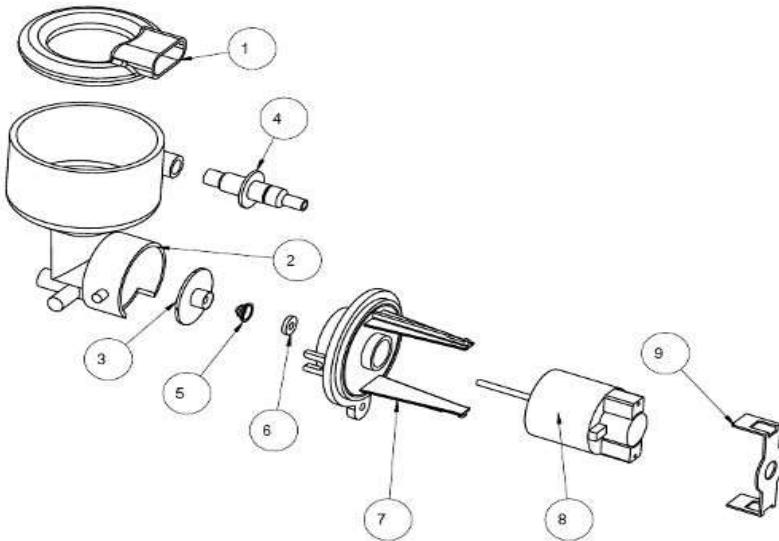



- (6) Remove the impellor disk ③ by pulling it in the direction shown.
- (7) Remove the whipper seal ⑤ and PTFE Washer ⑥ ensure that the running surface is smooth and free of ingredient residues.
- (8) Inspect whipper seal for damage and replace as necessary.
- (9) Wash all the removed mixing system components in de-tanning fluid and then rinse thoroughly with clean water.
- (10) Reassemble the mixing systems by following the reverse procedure.

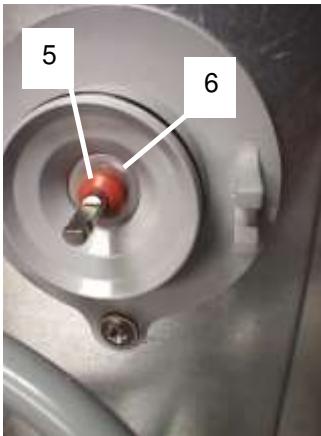

- (11) Ensure that both locking pegs ⑦ on the mixing system are correctly located by pressing firmly on the lower part of the mixing system.
- (12) When all mixing system components have been refitted, switch on the machine and perform a flush operation. Check the mixing systems for leaks and listen for abnormal sounds that may indicate incorrect assembly.

WEEKLY HYGEINE

CLEANING THE TEA BREWER

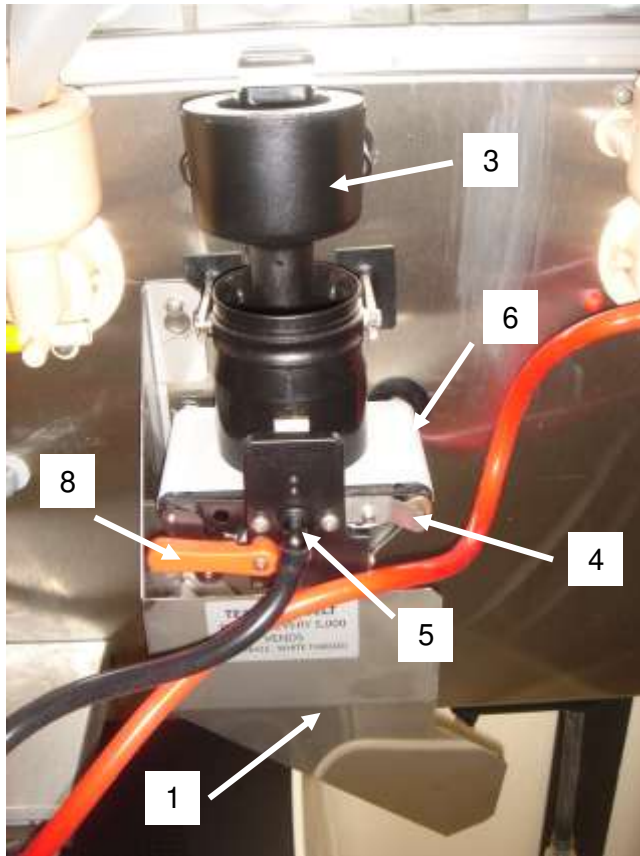

- (1) Open the door of the machine and switch machine off using the main switch.
- (2) Turn tea canister dispense chute upwards to prevent ingredients being spilled onto the floor of the machine.
- (3) Remove the tealeaf waste chute ① by lifting it upwards and towards you.
- (4) Remove outlet elbow ⑤, by pulling gently whilst turning the elbow slightly.

- (5) Raise the brewer release lever ④ to unlock the carriage assembly.
- (6) Gently slide carriage assembly ⑥ towards you and remove it from the machine.

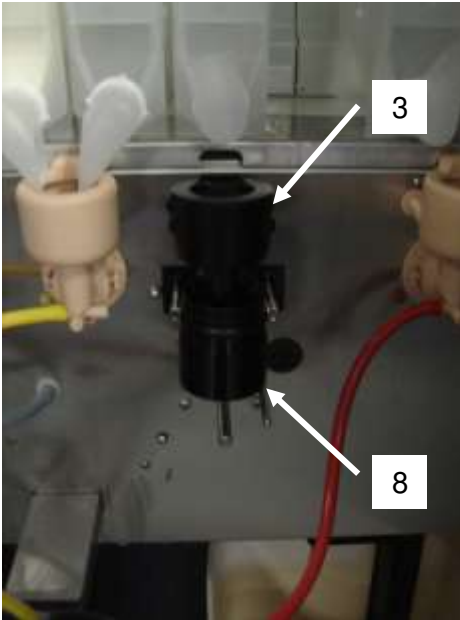

- (7) Remove mixing bowl ③
- (8) Remove the brewer cylinder ⑧ by swinging it upwards and then gently pulling forward in the direction indicated.



- (9) Wash the brewer and cylinder in de-staining fluid and rinse with clean water.

REFITTING THE TEA BREWER

- (10) Refit brewer cylinder.
- (11) Refit the mixing chamber.
- (12) Refit brewer carriage onto machine. If it does not locate correctly, gently turn filter belt using the studded roller until it slides into place.
- (13) Lock the carriage in place by returning the release lever ④ to the horizontal position; ensure that the groove on the lever engages with the slot on the shaft and that the carriage is secure.
- (14) Refit the tealeaf waste chute ① followed by the outlet elbow ⑤ and mixing bowl ③
- (15) Turn tea canister dispense chute downward into mixing bowl.
- (16) Switch machine back on. Ensure that hands and loose clothing are clear of the brewer(s).
- (17) Close and lock the machine door as instructed.
- (18) Once machine has reset, test at least one Tea.

- (19) Wash and dry the carriage and brew chamber assembly.
- (20) Inspect the filter belt and if necessary, remove and clean or replace it. Anticipated belt life is 2000 operations depending on the coffee grind, water hardness and frequency of washing. Belts may be washed in clean warm water or a de tanning agent to prolong their life. However, replacement will become necessary to avoid the brewer becoming blocked. Belt removal can only be done with the carriage removed. The procedure is to compress the tension roller between left hand forefingers and thumb (A). Then push in and rotate the red lever approximately a 1/8th turn clockwise (B). Having rotated the lever allows it to return in direction (C) to lock the tension rollers in the compressed position. The belt should be free to rotate and can be removed by sliding it back and forth whilst pulling it in direction (D).
- (21) To replace the belt, follow the first part of the above procedure to compress the tension roller. Then refit the new / cleaned belt. Release the tension roller by pressing the red lever in (B). It is not necessary to rotate the lever. It is spring tensioned.

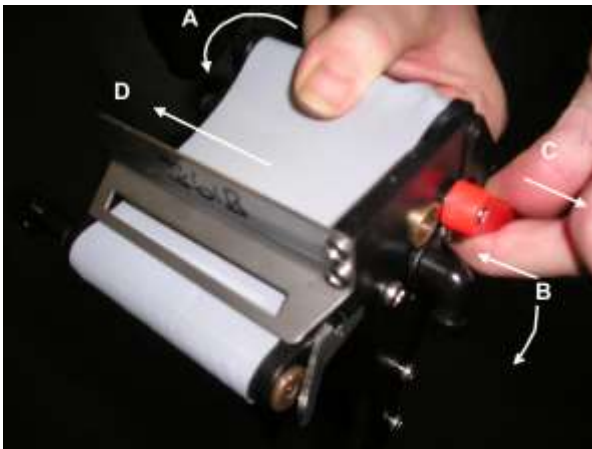

- (22) Disconnect the pipes from the mixing bowls and dispense head. Remove the mixing bowls, tubes and dispense nozzles, and also the whipper paddle and whipper base. Wash and dry these items.
- (23) Wash and dry the dispense area

- (24) Wipe clean all accessible inner and outer surfaces of the machine. Wipe dry.
- (25) Refit the whipper bases, paddles, mixing bowls, tubes and dispense nozzles and brewer parts. The assembly procedure for the brewer is the reverse of the disassembly procedure. Ensure that both brewer-locking levers are in the locked, (horizontal position) before proceeding to the next section.
- (26) Replace the grouts collection bin and refit the front cover, ingredient canister
- (27) Turn on the power. Note the brewer will cycle to reach its home position.
- (28) Carry Out a FLUSH operation, see below. Check that there are no leaks and that the brewer indexes properly. A container with a capacity of at least ½ liter should be placed beneath the dispense point to catch the liquid dispensed during the flush operation.
- (29) Filter Belt Replacement

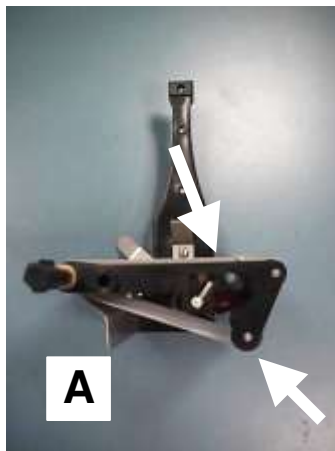

- (1) Using fore finger and thumb compress the tensioning rollers as shown in **A**.
- (2) With the rollers compressed push and turn the red lever ① to the locked position as shown in **B**.
- (3) With the rollers locked in the compressed position the belt can now be removed.
- (4) The belt may be cleaned using de-staining solution but will progressively become blocked with scale and therefore require more frequent cleaning. A new belt will perform approximately 1000 vends before cleaning is required. It is recommended that a belt is replaced in any case after approximately 3000 vends.
- (5) Replace the filter belt making sure to thread the bottom edge beneath the scraper plate. Once the belt has been threaded over all three rollers it can be eased into place by sliding it sideways whilst turning the drive shaft.
- (6) Once the belt is in place press the red lever to release the tensioning roller and tighten the belt.

FLUSHING THE “ESPRESSO” BREWER – TO BE DONE EVERY 3 MONTHS

- Ensure both the water waste and grout buckets are in place as they are

both used during this process. The total process will take approximately 5 minutes to complete.

- Press the “FLUSH BREWERS” button on the internal keypad.
- The machine will continually beep, and the internal display will show: (if there is a Tea brewer present this will flush at the same time)



- The brewer will move to various positions and will dispense water into the grout bucket.
- Once this initial flush has completed the machines beep will change and the internal display will show:



- Insert the tablet into the brewer and press Enter, pressing ESC or any other key will terminate the cleaning process.



- The internal display will now show:



- The cleaning of the “Espresso” brewer will now continue, at the end of the cycle the machine will do three black coffees to ensure all of the residue from the tablet has been purged from the system.

EXTRACT DUCT CLEANING

- (1) Open the door of the machine and switch machine off using the main switch.
- (2) Turn the ingredient nozzles upwards to prevent ingredient spillage and remove all canisters and extract hoods.
- (3) When all the canisters and hoods have been taken out, the extract duct cover can be removed by lifting it upwards and then forwards toward the front of the machine.

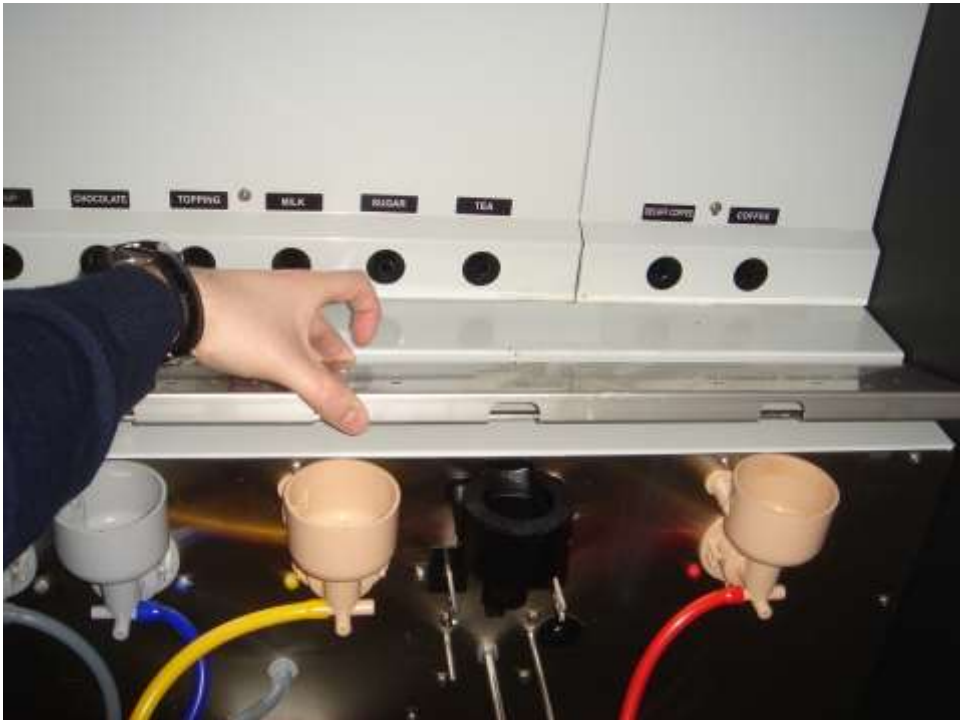

- (4) Thoroughly clean both the extract duct and its cover.
- (5) Refit the cover & replace the canisters.
- (6) Ensure all ingredient chutes are correctly positioned.
- (7) Switch on the machine and perform a flush operation.

FILLING

Instant Products

- (1) Turn the ingredient dispense chutes to face upwards to prevent ingredient spillage. Remove the instant product ingredient canisters from the machine. Remove the lid from each one in turn and fill it with the correct ingredient refitting the lid afterwards.
- (2) Place the canisters back in the machine ensuring that each one is in the correct position. Return the ingredient chutes to the correct dispense positions.
- (3) Restore the mains electrical supply to the machine and set the on/Off switch on the machine to ON.
- (4) Once the machine is powered up and turned on press the FLUSH button on the internal touch panel to ensure all residues has been removed from the mixing chambers when nozzles were being moved.

Bean Hopper

- (1) Remove the bean hopper lid and remove it. Fill the hopper with sufficient beans for the days anticipated use. Refit the hopper lid. Note any foreign objects that fall into the hopper should be retrieved before the machine is used further or damage to the grinder may result.

ACCESSING THE USER PROGRAMS

The programs are accessed by pressing key 5 (PROG) on the INTERNAL keypad.

The EXTERNAL display will then prompt for input of a four-digit entry code. The code is input using the numbers printed on the keys of the INTERNAL keypad.

After pressing the PROG key, the display will change to:

| |
|-----------------------------|
| PLEASE ENTER ACCESS CODE |
|-----------------------------|

Use the numbered keys on the INTERNAL keypad to enter the code 1111. It is not necessary to press ENTER. The code will be checked on entry of the fourth digit. Three attempts are allowed before the PROG key must be pressed again. On entry of a valid code the display will change to the menu.

Set Pricing Mode

Entering SET VEND PRICING allows the programmer to select one of the following pricing modes:

- NORMAL PRICES
- ALL DRINKS ARE FREE
- CHEAP DRINKS

The selected mode becomes the default setting to which the machine will return after any timed activities.

Change Prices

Entering CHANGE PRICES provides access to the following submenu:

- NORMAL PRICES
- ALL CHEAP PRICES
- ALL NORMAL PRICES
- OWN CUP DISCOUNT
- CHEAP PRICES

Entering NORMAL PRICES or CHEAP PRICES provides access to a list of drinks with corresponding prices. The price of a displayed drink can be changed by pressing ENTER, altering the value shown, and pressing

ENTER again.

Entering ALL NORMAL PRICES or ALL CHEAP PRICES provides access to a list of drinks with corresponding prices. The price of a displayed drink can be changed by pressing ENTER, altering the value shown, and pressing ENTER again.

Entering OWN CUP DISCOUNT allows the programmer to select the price of a plastic cup (and is preset at 0 pence). The value entered here is deducted from the normal price of a drink when there is no requirement for a dispensed plastic cup, i.e. when customers' own cups or mugs are used.

Neo + Machine Codes.

2GBNC4EFB50 NEO T/GB/EFB/73

2GBNC4EFB51 NEO T/GB/EFB/73/RBR



